

# Financial traders' network and systemic risk spill over channels

Jaehak Hwang\*

## Abstract

This paper investigates financial traders' network structure across different financial markets. As a proxy of traders' expectation on a trader's trading volume, I forecast a trader's trading volume on next day with machine learning technic. I estimate the network structure with the impact of the expectation of a trader's trading volume on other traders. I find some influential traders such as foreign investors within the network. Then, 3-phased impulse response analysis is also implemented to capture the connections between financial market volatility, traders' connectedness measures and traders' actual trading volumes. I find the evidences that traders' connectedness measures and their trading volume can function as a spill over channel of financial market volatility.

## 1 Introduction

A big player in the financial markets can have a significant influence to other traders or entire markets. If the size of market is not big enough when sudden liquidity shortage happens or some players have relatively huge amount of securities, the influence of a

---

\*Department of Economics, University of Bath, Bath BA2 7AY, Great Britain, E-Mail: J.Hwang@bath.ac.uk

big player could be more critical. Foreign investors in emerging markets during financial crisis are one of the most representative examples. In particular, Korea of which financial markets are widely open to foreign investors, is a good instance. Based on network analysis of Hwang (2018*a*), Hwang (2018*b*), it is shown that some traders such as foreign investors have been critically influential to other traders in financial markets, and that their contributions to financial market volatility have had impacts positively or negatively.

However, there are still some research gaps on the traders' financial network. First of all, the assumptions on the traditional econometric methodologies in extant literature are somewhat restricted in that the value of variables at present are determined simply by the past data. Although every driver to explain the present variables cannot be included in the model, the traditional econometric models are not enough to appropriately reflect the decision process in real trading behaviours. Instead, traders in real world have generally the expectations of not only the prediction of prices but also other traders' net trading volumes on next day, and they decide the amount of trading of next day based on their utmost expectations on the price and other traders' net trading volume. In that process, some traders who have much influence on others are more often utilised by the traders but others whose impacts are little, are less referred.

Secondly, the impacts of financial market volatility on traders' network structure are not investigated in Hwang (2018*a*) and Hwang (2018*b*), although the contribution of traders' connectedness measures on market volatility is examined. In particular, when internationally influential financial indexes such as S&P 500 fluctuates drastically, that influence can reach to the traders in emerging market countries as it did during Global financial crisis (GFC). If these relations are shed light on, it could be the key element to see traders' connectedness measure as a channel of systemic risk spill over. Thus, in this paper I try to investigate traders' financial network reflecting the real trading decision making process and the impacts of financial (or macro economic) indexes on traders' connectedness measures with similar data of Hwang (2018*a,b*).

The research questions are composed of two parts. The first one is which types of traders' daily net trading volume are considered as references by other market participants. In

order to answer this question, I relieve the restricted assumption of traditional econometric methods and predict traders' expectation forecast on other traders' daily net trading volume on next day. Second question is how the relation of financial market (macro economic) indexes, traders' connectedness measures and traders' trading is. Nonlinear impulse response analysis is implemented for answering this question. In order to effectively link those three variables, 3-phased impulse response analysis framework is applied.

I estimate traders' expectation forecast on other traders' daily net trading volumes above all. To quantify traders' utmost expectation on other traders' daily net trading volumes is a very tough task, for the expectation cannot be observed. However, if the daily net trading volume of next day can be forecasted appropriately, the forecasted value can be used as a proxy of best expectation. Nonetheless, forecasting time series variables, is not a simple job due to its stochastic characteristic. Although predicting time series data is inherently difficult and perfect prediction is an almost impossible task, forecasting with a certain level of accuracy could be very much helpful. Thus, Long Short Term Memory (LSTM), one of the machine learning techniques which have been rapidly developing nowadays is applied to estimate traders' forecast expectation.<sup>1</sup>

The expectation forecast on a trader's daily net trading volume on next day is utilised for the network structure estimation. In case that the expectation forecast on a trader (A) have a significant impact on the certain trader (B), it means that the trader (B)'s daily net trading volume is influenced by the expectation forecast on the trader (A). Based on all connections among traders, a network structure in a matrix form can be built and analysed with the connectedness measures. In addition, in order to observe the changes of the network structure over the time, monthly and daily networks are estimated. A few traders such as foreign investors and individual investors are shown to have an influence

---

<sup>1</sup>Machine learning can be defined as computer programming to have an optimized performance with past data. (Alpaydin (2014)) Machine learning technology has been already widely applied in financial industry. ("Machine-learning promises to shake up large swathes of finance", *The economist*) Unusual title like "head of machine learning" can be found in named financial companies. Machine learning are used in not only so-called front office jobs such as trading, but also middle or back office jobs such as compliance or risk management which needs to deal with heavy written documents rather than number crunching jobs. Besides the jobs such as fraud finding, credit assessment, insurance policy selling and claims management are gradually taken by machine learning techniques.

to others with both monthly and daily networks.

The linkage of financial (or macro economic) indexes, traders' connectedness measures and actual trading with nonlinear impulse response analysis is, then, also investigated. Due to the frequency of data, monthly and daily analysis are implemented separately.<sup>2</sup>

I find in the monthly analysis that, if the shock is given at financial indexes, a few traders such as BANK in FX derivative market, individual investors in stock market transform to be central, and that foreign investors in stock and stock derivative market and individual investors in FX derivative market react negatively. Given the shock of macro variables, the reaction of traders are different depending on the kind of shock. While foreign investors and individual investors respond actively at the shock on balance of payment, BANK reacts to the shock of unemployment rate and base interest rate.

Several further investigation are done in daily analysis with 3-phased structure which is composed of financial indexes, daily connectedness measures and traders' net trading volumes beside meaningful findings of monthly analysis. The aim of this approach is to investigate how the volatility of financial market transfers through traders' connectedness measures to traders' actual net trading volumes. Given the shock in a financial index, a few traders' connectedness measures react more sensitively than others. And given the shock in those network measures, some traders trade more or less actively. Finally at some traders' over-shot trading, a few other traders trade more or less. Three consecutive impulse response analyses are done to investigate the system risk transfer framework.

At the first phase, top 3 positively (negatively) responding connectedness measures to the shock of financial indexes, converge to particular three traders who are individual investors in stock and FX derivative market, collective investment scheme in stock and FX derivative, and foreign investors in stock and bond derivative market. This result is

---

<sup>2</sup>Macro economic variables are normally announced with monthly basis so that the relationship between macro economic variables and monthly traders' connectedness measures are investigated. Traders' daily net trading volume cannot be linked with those two variables. Thus, in case of daily frequency, financial market volatility, daily traders' connectedness measures and traders' daily net trading volume can be investigated altogether.

same to the different shocks from 5 different financial markets. Given the shocks on the connectedness measures of 6 traders who are the most responsive at first phase, the most sensitive responses are found at the other markets, which are different from the sources of shocks. The shocks converge to certain traders at first phase, but diverge to different markets at second phase. Finally, it is found that there is an autocorrelation at the shock of traders' net trading volumes at third phase. The biggest responses to the shocks of those 6 traders who are the most sensitive at second phase, are shown in the same traders. Comprehensively based on those results, it is evident that market volatility spill over channels in capital markets exist, and that some particular traders' connectedness measures and other specific traders' daily net trading volumes can be the channels.

Several important contributions to earlier relevant literature are present in this paper. To my best knowledge, the forecasting of trader' daily net trading volume is first trial in econometric research and even in machine learning literature. The result of forecasting helps to understand traders' real trading behaviour and to estimate network structure of traders. In addition, this paper fills the gap in understanding traders' network structure in capital market through the impulse response analysis on financial (macro economic) variables, traders' connectedness measures and traders' actual trading volumes. Lastly, the systemic risk spill over channels are investigated under the 3-phased framework and the evidences which traders' connectedness measures can be the market volatility spill over channels, are provided. The results of this paper have a few benefits to not only the researchers, but to policy maker and practitioners. Policy makers or regulators are able to better measure the market risk with the information of the channel of market volatility spill over and to prepare for the extremely risky situations in advance. Furthermore investor-tailored policy can be launched for stabilizing the market volatility.

The structure of this paper is as follows. In section 2, I discuss related previous literature. In section 3, I present the methodologies. In section 4 the explanation about the data analysed is provided. Monthly result is given in section 5. Section 6 is about market volatility spill over channels with daily result. Section 7 describes conclusion and final remarks. In addition, detailed information about expectation forecast is provided in

appendix A.

## 2 Literature review

This section is divided into several sub sections. First of all, I summarise Hwang (2018*a*) and Hwang (2018*b*), which initiated the investigation of traders' network in Korean capital markets. The areas which were not covered with that research, are the main interests of this paper. The theoretical and empirical studies on expectation formation are reviewed then. Through that research, the backbone of the model in this paper is provided. Forecasting methodologies and the applications are also widely covered afterwards. Traditional econometric methods and machine learning methods are compared and the method with the best performance is used for the analysis. Lastly, the literature on market volatility or risk spill over is reviewed.

### 2.1 Traders' financial network

Hwang (2018*a*) and Hwang (2018*b*) estimated traders' financial network with ten years' daily trading data from Korean financial markets and analyse the network structures with various perspectives. He tried to estimate the interconnectedness with two representative methods (Kara et al. (2015)), which are granger causality method and generalized variance decomposition. Furthermore, Hwang (2018*b*) developed more with nonlinear granger causality method and nonlinear generalized variance decomposition from linear methods of Hwang (2018*a*).

He found the influential traders within the network structure by the time period and foreign investors' trading patterns. Foreign investors and derivative markets were shown to be relatively more influential than other traders and markets. Then, he also showed the extent each trader's connectedness measure contributes to the change of financial market volatility. Foreign investors did not contribute to the increase of market volatility, while

other influential traders had substantial contribution to market volatility.

However, his research still had some parts for further developments. Firstly, traditional econometric methods with VAR (Vector autoregression) representations have too restrictive assumptions that actual trading decision making process is hardly reflected in the model. In addition, the impact of financial market volatility increase on traders' connect-  
edness measures were not investigated.

## 2.2 Expectation building

In numerous previous literature in finance and economics, an agent's expectation has been studied in diverse perspectives. One of the most representative examples was to investigate the oscillation of market price or the price bubbles, which included not only stock price bubble, but also classical bubbles like Dutch Tulipmania or Mississippi bubble. They saw the agent's expectation as the cause of bubble. There have been active debates on why those bubble were formed and how traders' expectation functioned in financial markets, although there is no explicit consensus.

On one side of that debate the research have stressed on traders' rationality which were based on rational expectation hypotheses since Muth (1961). They interpreted the price fluctuation was a process in which traders' rational expectation converged to the equilibrium price level. Even bubble was interpreted as the result of speculative investors' rational expectation. Recently rational expectation has developed to bounded rationality (Sargent (1993)) and adaptive learning (Bullard (2006)).

On the other side there have been the studies which admitted the existence of noise traders, who acted irrationally. In their studies, noise traders' mass uniform behaviours which were so-called herding and also called "animal spirits" by Keynes (1936) and Akerlof & Shiller (2010). Their approach to the expectation was not based on the rationality, which occurred market fluctuations.

Regardless of the approaches to expectation, agent's expectation has a dynamic attribute,

which means that traders coordinate their expectation according to the market conditions. Thus, by the traders' attitudes on their expectation, economic outcomes vary. This phenomenon has been in general considered as an expectation feedback system.

There are two types of expectation feedback system which are positive and negative feedback system. Heemeijer et al. (2009) explained expectation feedback system with the concept of strategic substitutability (complementarity). Strategic substitutability (complementarity) exists when an increase of trader  $i$ 's action gives an incentive for trader  $j$  to decrease (increase) his action. By their explanation, strategic substitutes (complements) are negative (positive) expectation feedback. Tedeschi et al. (2012) provided an intuition how the noise trader's positive feedback worked. Supposing noise traders with pessimistic expectation and rational traders to buy the asset. Due to the noise traders' selling, rational traders coordinate their expectation not to buy, which drives the asset price down. If in opposite case that noise traders with positive expectation and rational traders to sell the asset. Then, noise traders buy more asset and rational traders update their opinion not to sell. Finally the price is not likely to converge to equilibrium level.

The expectation, however, is hardly to be measured and to be acquired in the market, since traders in general have heterogeneous expectations and the expectation cannot be observed. Thus, much research have been implemented under experimental circumstances or with simulation approaches. Some studies try to obtain survey data. ter Ellen et al. (2013) and Prat & Uctum (2015) obtained traders' expectation data with survey on the currency markets.

The discussion on traders' expectation by far gives an intuition of traders' inter-relations in capital markets which are mainly investigated in this paper. The past behaviours on influential traders can form the other traders' expectation on those influential traders, which will determine traders' trading behaviours on next stage. Then, some of them could give an impact on the market volatility in either positive or negative direction.



## 2.3 Forecast methods

Related works in methodology are categorized into two classes. The first class is statistical or econometric time series forecasting. As ARIMA suggested by Box & Jenkins (1976) is one of the most commonly used econometric methodologies, much research has been done with ARIMA and the areas to which ARIMA was applied are diverse.

Since Box & Jenkins (1976) ' publication of " *Times series analysis:forecasting and control*", there have been enormous developments in time series forecasting.(Tsay (2000)) Autoregressive Integrated Moving Average(ARIMA) was first introduced by them and widely used to forecast time series in many area since then. With technical and theoretical development, the trials to accurately predict time series data have been done with diverse approaches. Generalized autoregressive conditional heteroskedasticity(GARCH) type models were also introduced to capture the dynamic volatility of time series. The appearance of Markov chain Monte Carlo(MCMC) helped to solve more complicated problems and increased simulation approaches.(Tsay (2000)) Despite of these huge statistical and econometric development in time series forecasting, those models should have the theoretical model in order to predict. In practice, that attribute can be a strong restriction.

Enormous previous literature applied econometric models to forecast diverse variables. Malik et al. (2017) forecasted 5 big banks' stock prices in Pakistan. They also examined whether Pakistan stock market was efficient with ARIMA model. Dhingra et al. (2017) predicted daily Foreign Institutional Investment (FII) flow in Futures market with ARIMA. They analysed the relations of daily FII and foreign investors' daily net position in futures market. Their result enhanced the understanding of the influence of FII to futures market. Diaz & Chen (2017) investigated the return of Currency EXchange-traded Notes(ETNs) with ARFIMA-FIGARCH which was autoregressive fractionally integrated moving average-fractionally integrated generalized autoregressive conditional heteroskedasticity model. They found non-stationarity and non-invertibility and concluded that currency ETNs market was not efficient. Sole Pagliari & Ahmed (2017) also used

ARIMA model in their research on capital flow volatility, macroeconomic and financial stability in emerging market. Mehran & Shahrokhi (1997) forecasted Mexican Peso per US dollar rate with ARIMA. They showed that ARIMA model predicted future spot rates better than forward rate model, spot rate or regression model and Naive or Random walk. Tse (1997) analyzed property prices in Hongkong with ARIMA method. They mentioned that ARIMA model had an excellent short term forecasting power. Herbst et al. (1989) suggested more accurate currency hedge ratio using ARIMA, while the other statistical methods gave upward bias. Iler (1985) forecasted macroeconomic variables with vector ARIMA. Nagayasu (2003) investigated the efficiency of Japanese stock market using ARFIMA model which was variant of ARIMA and found that Japanese stock market was inefficient.

The second category is forecasting with neural network methods, which is also known as "machine learning". Time series forecasting with neural network method is not restricted within economic or financial fields. Some research (Claveria et al. (2017)) tried to predict tourism and showed accurate prediction result. This means that machine learning technique can be applied to wider area than expected. However, in this section I describe financial and economic forecasting mainly since financial time series has particular attributes such as nonlinearity, nonstationarity, and random walk.

The most evident difference between econometric methods and machine learning techniques is that machine learning techniques like Artificial Neural Network(ANN) for time series prediction are free from the restriction of theoretical models. In machine learning area there's no need to assume the relationship between the variables. Although theoretical analyses cannot be done in machine learning methods, recent research showed the prediction results of them outperformed traditional econometric methods in most cases. Besides, in line with a rapid development of machine learning methods, they have been popularly applied in the area of time series prediction.

One of the main areas is stock price prediction. A number of research in this area has been done. Atsalakis & Valavanis (2009) surveyed, reviewed and classified over 100 articles which were published by 2006, focusing on input data, methodologies, and performance

measures. They showed that machine learning techniques' forecasting performances excelled traditional models in general, while there would be some difficulties to make a structure of models. In most cases, the model was built by trial and error procedures. Even after their survey, much more research in stock price forecasting has been done with diverse and hybrid methods.

Zhang & Wu (2009) predicted S&P 500 index with neural network method and showed good performance. De Faria et al. (2009) forecasted Brazilian stock index with Artificial Neural network (ANN) and adaptive exponential smoothing methods. They found that the performance of ANN was more accurate than statistical method. Chen et al. (2017) forecasted high-frequency (5 minutes) stock price with double-layer neural network(DNN) and found that their forecasting outperformed other econometric methods such as ARMA-GARCH and ARMAX-GARCH. Chaudhuri et al. (2017) predicted the ratio of shares prices of stock pair trading with Support Vector Machine(SVM), Random Forest (RF) and Adaptive Neuro Fuzzy Inference Systems (ANFIS).

The other area which machine learning methods were widely applied is currency value prediction. Chaudhuri & Ghosh (2016) forecasted exchange rate of Indian rupee with Artificial Neural Network (ANN) and other time series econometric modeling such as GARCH and EGARCH. Majhi et al. (2009) forecasted foreign exchange rate with their proposed neural network method which were Functional Link Artificial Neural Network (FLANN) and Cascaded functional Artificial Neural Network (CFLANN). Their approach showed better performance than standard LMS (Least mean squares) models. Maknickien et al. (2011) used Recurrent Neural Network to forecast currency value and proposed a new approach of Evolution of recurrent systems with linear outputs(EVOLINO).

Derivatives price or volatility have been predicted with machine learning technologies. Cao & Tay (2003) used Support Vector Machine (SVM) to forecast 5 real futures contracts. The performance of SVM was found to be better than Back propagation neural network. Son et al. (2016) showed that nonparametric machine learning models were better than conventional parametric models on forecasting CDS spreads. Wang (2009) forecasted stock option price in Taiwan. In order for that, volatility was predicted using GARCH

models. The result was that neural network option pricing model was better.

Various commodity prices are also the field which machine learning techniques have been widely applied to forecast. Gao & Lei (2017) forecasted crude oil price with streaming learning, which was the methodology fit for non-stationary continuous data. They found that their model outperformed Artificial Neural Network (ANN) approach. Wu & Duan (2017) forecasted gold future price at Shanghai Futures Exchange with Elman neural network. They showed that the prediction result of neural network had highly accurate and could suggest an alternative investment strategy. Muzhou et al. (2017) predicted tungsten price with Hybrid Constructive Neural Network Method(HCNNM). They showed their suggested method have the superiority to traditional methods. Hernndez (2017) executed the analysis of metal prices volatility prediction. They utilized forecasted variables of GARCH models as input variables in neural network model. Their results also showed that neural network model improved prediction power of time-series models.

Some research suggested new novel and hybrid methods and tested their methods with multiple types of financial time series. These type of research proved that machine learning techniques can be applied wider areas than expected. Parida et al. (2017) implemented their novel model Locally Recurrent Neuro Fuzzy Information System (LRNFIS) which was a hybrid form of fuzzy neural network and a functional link neural system. They forecasted electricity price, exchange rates and stock indexes. Pradeepkumar & Ravi (2017) tried to predict the volatility of diverse financial time-series such as currency, gold, oil and stock indices. They suggested a novel approach, Particle Swarm Optimization - trained Quantile Regression Neural Network (PSOQRNN). They found that their new method outperformed to forecast those time-series.

Beside the financial data mentioned above, a variety of research has been done on different time series. Khwaja et al. (2017) improved short-term electric load forecasting performance with boosted neural networks (BNN). Sokolov-Mladenovi et al. (2016) predicted GDP growth rate with artificial neural network(ANN). Mahmoudi et al. (2017) predicted earning management of Iranian listed companies of Tehran stock exchange using Artificial Neural Network(ANN). Their result proved that ANN had the prediction

power. They also showed that their approach had many benefits compared to earlier literature, in particular for ANN had no need to assume the relationship between the input variables and out variables.

Recently, some researchers tried to combine econometric model and machine learning techniques. Parida et al. (2017) proposed a hybrid approach of fuzzy neural network and Chebyshev polynomial functions. They predicted 3 different time series which were electricity price, currency exchange rates and stock indexes. Their results gave clues that time-series could be forecasted accurately. Pradeepkumar & Ravi (2017) suggested a novel approach, Particle Swarm Optimization trained Quantile Regression Neural Network (PSOQRNN) and predicted volatility of financial time series. The time series they forecasted were exchange rates, Crude Oil prices and Stock indexes. They showed that their approach outperformed Generalized Autoregressive Conditional Heteroskedasticity (GARCH) and Neural Network methods.

## **2.4 Market volatility or systemic risk spill over channels**

Up to date, there is no precise definition of systemic risk in financial markets, risk spill over and contagion channel. Pei & Zhu (2017) divided financial contagions into 3 categories which were volatility spill over, extra co-movements of asset returns, and severe systemic instability by a shock. And they also suggested potential transmission channels, which were international trade links, investors' behaviours, information asymmetry, liquidity shortage and so on.

At the investigation of Guidolin & Pedio (2017) on financial risk contagions within European markets, four different risk contagion channels which are the flight-to-quality, flight-to-liquidity, risk premium, and correlated information channels. Flight to quality and flight to liquidity means when the shock is given, the investors move to safer and liquid assets. Risk premium is that the investors become more risk averse, which leads to increase risk premiums of assets. Correlated information means that the shock occurred in a market provides the information reflecting equilibrium values of other assets that is

not directly influenced by that shock.

Among the literature studied systemic risk spill over, some focused on the financial institutions as the contagion channel. Ghulam & Doering (2017) investigated the risk spill over among the financial institutions in UK and Germany. They found that hedge fund played an important role to transmit financial risk in both countries. Their finding is closely linked to the financial regulation issues. In particular, German insurance companies are less interconnected with bank than in UK since Germany has more powerful regulation on insurance industry. Furthermore, although their result on hedge fund seems similar to Adams et al. (2014) using US data, European hedge funds do not transmit the financial risk such as extremely like American ones.

On the contrary others concentrated on the market indexes. Leung et al. (2017) investigated hourly volatility contagion with 3 stock indexes (New York, London and Tokyo) and 4 exchange rates (USD, EUR, GBP and JPY). They found that during crisis period spill over effect increased. Their approach was distinguishing for they separated the drivers of contagion, which were pure contagions triggered by irrational investors, and fundamental contagions captured by macroeconomic fundamentals.

Some research tried to connect network theory with risk spill over studies. Jeong & Park (2017) tried to link the connectedness measures of Korean financial institutions and their stock volatilities. Their finding provided a proof of "Too interconnected to fail". Wei & Zhang (2016) analyzed Chinese P2P lending risk contagions with network modeling and simulations. They found that the financial institutions which had the relationships with P2P lending lenders amplified the risk within the network. Moreover, with the dynamic setting, information asymmetry played an important role within the network.

### **3 Methodology**

In this paper, the analyses are divided into two parts. One is the network estimation with expectation forecasting. The expectation of other traders' daily net trading volumes on

next day can be one of the key references for a trader to decide his or her trading on next day, since major players' massive trading can occur enormous changes of financial asset prices and traders' behaviours. However, traders' expectation on other traders' trading on next day is impossible to observe, so that forecast values are used as the proxy of the expectation. The detailed process and result are present at appendix A.<sup>3</sup> The network structure, then is estimated based on the relations of forecast values' influence to traders' trading volume. Network estimation processes are addressed below.

The other part is to measure traders' responses on the market shock and to investigate the market volatility spill over channels. As a market volatility spill over channel, traders' network (connectedness) measures and trading volumes are applied. Traders' network measures are acquired with the network structure which is already estimated. Then, the responses of traders' network measures and trading volumes are examined at the shock of financial indexes. The details of how to investigate are given below as well.

### **3.1 Network estimation with expectation forecasting**

In this part, I build the model to see how the traders reflect their utmost expectation on other investors' net trading volume on next day with nonlinear granger causality measures which are applied in Hwang (2018*b*). Since there is no evidence that the relation between traders' net trading volume is linear, nonlinear granger causality which can also capture the linearity is used instead of traditional linear granger causality method.

---

<sup>3</sup>I forecast every trader's daily net trading volume on next day as a proxy of traders' expectation on the trader. In order to determine the most appropriate method, I apply three methodologies which are traditional econometric model (ARMA/ARIMA), artificial neural network (ANN) and long short term memory (LSTM). After forecasting, I compare the performances of those three methods. As a result, LSTM shows the best forecasting performance. Therefore, I use the forecasting results with LSTM for network structure estimation.

Table 1: Definition of variables

|            | IND           | BANK           | FI           | CIS           | OTH           | INS           | GOV           | FOR           |
|------------|---------------|----------------|--------------|---------------|---------------|---------------|---------------|---------------|
| Stock      | $x_{ind,su}$  | $x_{bank,su}$  | $x_{fi,su}$  | $x_{cis,su}$  | $x_{oth,su}$  | $x_{ins,su}$  | $x_{gov,su}$  | $x_{for,su}$  |
| Stock Drv. | $x_{ind,sd}$  | $x_{bank,sd}$  | $x_{fi,sd}$  | $x_{cis,sd}$  | $x_{oth,sd}$  | $x_{ins,sd}$  | $x_{gov,sd}$  | $x_{for,sd}$  |
| Bond       | $x_{ind,bu}$  | $x_{bank,bu}$  | $x_{fi,bu}$  | $x_{cis,bu}$  | $x_{oth,bu}$  | $x_{ins,bu}$  | $x_{gov,bu}$  | $x_{for,bu}$  |
| Bond Drv.  | $x_{ind,bd}$  | $x_{bank,bd}$  | $x_{fi,bd}$  | $x_{cis,bd}$  | $x_{oth,bd}$  | $x_{ins,bd}$  | $x_{gov,bd}$  | $x_{for,bd}$  |
| FX Drv.    | $x_{ind,fxd}$ | $x_{bank,fxd}$ | $x_{fi,fxd}$ | $x_{cis,fxd}$ | $x_{oth,fxd}$ | $x_{ins,fxd}$ | $x_{gov,fxd}$ | $x_{for,fxd}$ |

[Note] Definition of traders and market (For simplicity, time t is excluded in each variable.)  
(trader)

IND = Individual trader, BANK = Bank, FI = Financial investment(mainly securities companies)

CIS = Collective Investment Scheme, OTH = others (small financial companies), INS = Insurance companies

GOV = Government, FOR = Foreign investment

(market)

SU = stock, SD = stock derivative, BU = bond, BD = bond derivative, FXD = FX derivative

### 3.1.1 VAR representation

In this paper in order to investigate traders' relation, I use each trader's daily net trading volume which is provided by Korea exchange<sup>4</sup> and Korea financial investment association

<sup>5</sup> Based on the data, eight types of traders who are individual investors (IND), BANK, Financial investment (FI), collective investment scheme (CIS), insurance (INS), government (GOV), foreign investors (FOR), and others (OTH), from five different financial markets which are stock (SU), stock derivative (SD), bond (BU), bond derivative (BU), and FX derivative (FX) are analysed. On the table 1, all traders and markets are shown. Daily net trading volume shows how much a trader buy or sell on net trading in a day after offsetting gross buying and selling. For avoiding excessive influence of a big size of market and analysing traders' trading in different market with same weights, I adjust daily net trading volumes as seen on the equation (1).

$$x_{t(i),m(j)} = \frac{\text{daily trading volume of trader } i \text{ in market } j \times 2}{\sum |\text{daily trading volume of trader } i \text{ in market } j|} \quad (1)$$

where  $t()$  indicates the trader and  $m()$  shows the market. The list of traders and markets is given in the table 1. For the efficient analysis, the vector of traders' daily net trading volume at time  $t$  ( $X_t$ ),  $X_t = (x_{ind,su,t}, x_{bank,su,t}, \dots, x_{gov,fxd,t}, x_{for,fxd,t})$  can be

<sup>4</sup>www.krx.co.kr

<sup>5</sup>www.kofia.or.kr



considered.

Then, a VAR(Vector Autoregressive) model with  $X_t$  can be considered as seen on equation (2). Traders' daily net trading volumes are determined by the net trading volumes at previous day. The model order one is consistent with extant literature (Song & Taamouti (2016), Hwang (2018a)). That is the restricted model.

$$X_{t+1} = \Phi^{re}(X_t) + \epsilon_t \quad (2)$$

Where  $\Phi^{re}()$  is nonlinear function, which I apply Gaussian kernel regression for the simplicity as Song & Taamouti (2016).  $\epsilon_t$  is the error term.

The assumption which the past simply determines the future, however, is so restricted that an unrestricted model with expectation forecasting is suggested (equation (3)). Expectation forecasting is the utmost forecast on a trader's daily net trading volume on next day by other market participants. In this paper, the value of expectation forecasting is estimated with LSTM(Long short term memory), which is one of the most popularly used machine learning technologies in time series forecasting.<sup>6</sup> In unrestricted model, traders' daily net trading volume on time t,  $X_t$  and a certain trader's expectation forecasting vector on time t+1,  $E_t[x_{st(k),sm(l),t+1}|X_t]$  whose dimension is  $40 \times 1$  composed of same value (the expectation forecasting on the trader), are used as independent variables. Here st() stands for source trader which means the trader with the expectation forecast and sm() means source market which is the market source trader belongs to. What matters is that the expected value is conditional on all other traders' trading history  $X_t$ . Thus, by the trader and market, 40 different unrestricted models can be made.

$$X_{t+1} = \Phi^{un,st(k),sm(l)}(X_t, E_t[x_{st(k),sm(l),t+1}|X_t]) + \epsilon_t \quad (3)$$

---

<sup>6</sup>In this paper, I compare the forecast performance of traditional econometric method (ARMA/ARIMA), neural network, and LSTM as seen in appendix A. LSTM is shown to have the best performance.

Where  $\Phi^{un,st(k),sm(l)}()$  is nonlinear function, which apply Gaussian kernel regression is applied.  $\varepsilon_t$  is the error term. According to the type of trader and the market which the trader belong to, 40 different unrestricted models are made.

### 3.1.2 Nonlinear granger causality measures

I measure how much the traders receive an influence from the expectation forecasting on a certain trader. For instance, individual investors in stock market might refer their expectation on foreign investors' trading in stock derivative market on next day. That influence can be captured with granger causality measure.

$$C_{t(a),m(i) \rightarrow t(b),m(j)} = \ln\left(\frac{\sigma_{re}^2(x_{t(b),m(j)})}{\sigma_{un}^2(x_{t(b),m(j)}|st(a),sm(i))}\right) \quad (4)$$

where  $\sigma_{re}^2(x_{t(b),m(j)})$  is forecasted error of  $x_{t(b),m(j)}$  with restricted model and  $\sigma_{un}^2(x_{t(b),m(j)}|st(a),sm(i))$  is forecasted error of  $x_{t(b),m(j)}$  with unrestricted model which has the expectation forecast of source trader  $a$  and source market  $i$ . Regarding all traders, the pairwise causal relationship can be obtained with granger causality measure. Then, causality matrix (C) can be acquired based on them as seen on table 2. One thing matters here is that all causality measures need to be checked with statistically significance test.

For the statistical significance of granger causality measure, simple bootstrapping method is applied. Bootstrapping is the statistical method to estimate the distribution of statistics with random sampling with replacement, which was introduced by Efron and Tibshirani (1993) and developed more since. It is basically computer-based method and in many cases costs time-consuming jobs. That's why simple bootstrapping method is implemented in this paper although diverse versions of bootstrapping can be applied.

Simple bootstrapping method is composed of following algorithm. After estimating regression equation with the observed  $X_{t-1}$  and  $X_t$ , residuals  $\epsilon$  can be computed. Then, fixing  $X_{t-1}$  and randomly sampling the elements of  $\epsilon$  with replacement,  $\epsilon^*$  can be drawn.  $\epsilon^* = (\epsilon_1, \epsilon_2, \dots, \epsilon_n)$ . The value of each  $\epsilon_i$  is same with one of the elements of  $\epsilon$  which

Table 2: Granger causality matrix

| $c_{i,j}$ | 1          | 2          | ... | j          | ... | 39          | 40          |
|-----------|------------|------------|-----|------------|-----|-------------|-------------|
| 1         | $c_{1,1}$  | $c_{1,2}$  | ... | $c_{1,j}$  | ... | $c_{1,39}$  | $c_{1,40}$  |
| 2         | $c_{2,1}$  | $c_{2,2}$  | ... | $c_{2,j}$  | ... | $c_{2,39}$  | $c_{2,40}$  |
| ...       | ...        | ...        | ... | ...        | ... | ...         | ...         |
| i         | $c_{i,1}$  | $c_{i,2}$  | ... | $c_{i,j}$  | ... | $c_{i,39}$  | $c_{i,40}$  |
| ...       | ...        | ...        | ... | ...        | ... | ...         | ...         |
| 40        | $c_{40,1}$ | $c_{40,2}$ | ... | $c_{40,j}$ | ... | $c_{40,39}$ | $c_{40,40}$ |

can be with probability of  $1/n$ . Using  $\epsilon^*$  and fixed  $X_{t-1}$ , new  $X_t^*$  can be calculated. Then with  $X_{t-1}$  and  $X_t^*$ , new causality matrix  $C^*$  calculated. All above procedures are repeated 1,000 times. Achieved significance level(ASL) can be obtained like below.

$$ASL = \#\{C^* \geq C\}/N \quad (5)$$

where N is repetition time. Here, hypothesis( $H_0$ ) is  $C = 0$  and one-tailed test is used since causality measure is assumed to be greater than or equal to 0.<sup>7</sup> If a causality measure is statistically significant, it means that a trader is influenced by the expectation forecasting on a certain trader.

Every trader's influence on all other traders can be captured with granger causality measures in this fashion. With those granger causality measures, granger causality matrix  $C$  can be made consequently like table 2. The entry of granger causality matrix  $C$  can be shown  $c_{i,j}$ , which means expectation forecast on the trader  $i$  on row influence the trading of trader  $j$  on column. In other words, trader  $j$  refers his/her expectation on the trading of trader  $i$  on next day. If the entry of granger causality matrix is statistically significant at 10% significance level, the value of the entry is 1, otherwise it is 0. Then, adjacency matrix whose entries are composed of 1 or 0 can be drawn easily.

<sup>7</sup>I use causality matrix  $C$  instead of the entry ( $c_{ij}$ ) of causality matrix  $C$  for simplicity. Here causality matrix  $C$  is expressed comprehensively as the combination of all causality measures which are the entries of causality matrix ( $C$ ).

### 3.1.3 Connectedness measures

Although granger causality matrix is obtained, it is still hard to measure a trader's influence to others within the network. Thus, a measure to capture the influence of expectation forecasting on a trader to other traders needs to be defined. I use OUT and IN connectedness measures in this paper, which are similar concept with degree centrality. It is one of the simplest and mostly used network measures in network literature.(Newman (2010)) Centrality literally means how central a node or vertex in the network and is defined as the sum of edges which connect the node. In direct network which has a direction in the edge like granger causality matrix, two kinds of connectedness measures can be defined. One is OUT connectedness measure which is a node's influence to others. The other is IN connectedness measure which is the influence of others to a node.<sup>8</sup>

$$OUT(i) = \sum_{j=1, j \neq i}^N c_{i \rightarrow j} \quad (6)$$

where  $c_{i \rightarrow j}$  is the value of granger causality measure from expectation forecast on trader  $i$  to the trading of trader  $j$  which is the element of causality matrix  $C$ .

$$IN(i) = \sum_{j=1, j \neq i}^N c_{j \rightarrow i} \quad (7)$$

where  $c_{j \rightarrow i}$  is the causality value from expectation forecast on trader  $j$  to the trading of trader  $i$  which is the element of causality matrix  $C$ .

### 3.1.4 Changes of network structure

Given the causality matrix and connectedness measures, network structure and influential traders can be easily investigated. However, one causality matrix during the entire

---

<sup>8</sup>For the actual computation, all OUT and IN connectedness measures are divided by the number of all traders (40). Because all causality values are binary (1 or 0) in this paper. In addition, it helps to avoid the scale problem in impulse response analysis.

analysed period is not enough to capture changes of traders' network structure. Here I estimate monthly and daily network structures. The process to estimate monthly and daily network is described below.

First of all, the entire data set needs to be divided into sub periods. Here I use two years moving window method by one month. For instance, the values of December in 2010 are estimated with the data from the beginning of 2009 to the end of 2010. Regarding all sub periods data with two years, two processes of monthly network structure estimation are implemented. One is the prediction of expectation forecasting on 40 different traders. Expectation forecasting is predicted with LSTM which has the best performance among traditional econometric method, artificial neural network, and LSTM. The other is to estimate monthly causality matrix and traders' connectedness measures. Causality matrix is estimated with the method, which is described above and connectedness measures are calculated as seen on equation (6) and (7). In this way 96 monthly OUT/IN connectedness measures of 40 traders are obtained.

Although changes of network structures can be investigated with traders' monthly connectedness measures, it is still hard to link the network measures and financial market index. Since the data frequency of most of financial market indexes is daily basis. Thus, daily connectedness measures are estimated with similar methods with monthly network structure estimation. Reflecting daily frequency, I use 30 days moving window method by one day. The same values of expectation forecasting are used.

## **3.2 Impulse response analysis**

In this section, the relation of financial (or macro economic) variables, traders' connectedness measures and traders' actual trading is investigated. Given the fact that trading activity should be accompanied for financial market fluctuation, traders' network structure can play an important role to examine the propagation of financial market volatility. Whether market volatility can affect traders' connectedness measure, is also examined at the same time. Two versions of Impulse response analyses, which are monthly and daily,

are applied to investigate.

### 3.2.1 Monthly Impulse response analysis

In order to investigate the relation of traders' connectedness measures and financial or macro variables, network (connectedness) measure vector  $N_{a,t}$  needs to be defined. Network Vector  $N_{a,t}$  is defined as the combination of all traders' connectedness measures and one of financial or macro variables, as  $N_{a,t} = [n_{t(ind),m(su),t}, \dots, n_{t(for),m(fxd),t}, f_{a,t}]'$ .  $f_{a,t}$  ( $a=1, \dots, 10$ ) is one of the financial or macro variables. Financial variables are the monthly volatility of KOSPI ( $a=1$ ), KRW/USD ( $a=2$ ), S&P ( $a=3$ ), NIKKEI ( $a=4$ ), and HANGSENG ( $a=5$ ). Macro variables are current account of balance of payment ( $a=6$ ), capital and financial account of balance of payment ( $a=7$ ), inflation rate ( $a=8$ ), unemployment rate ( $a=9$ ), and base interest rate ( $a=10$ ). All financial/macro data are adjusted from 0 to 1, since traders' connectedness measures are within 0 and 1. This adjustment has a benefit to avoid the distortion of variables' scale difference. For entire data set, minimum value is adjusted to 0, maximum value is modified to 1 and others are interpolated between 0 and 1. Then, simple VAR model, which is called as "baseline model" here can be built.

$$N_{a,t+1} = \phi_m(N_{a,t}) + \varepsilon_t \quad (8)$$

Where  $\phi_m()$  is nonlinear function, which is Gaussian kernel here.  $\varepsilon_t$  is error term. According to  $a$  (financial or macro variables), ten different VAR model can be built.

Then, for investigating the responses of traders' connectedness measures on the shock of financial or macro variables, Impulse response function (IRF) needs to be defined. In this paper I follow the simulation approach by Koop et al. (1996). This approach has the advantage to capture nonlinear relations between impulse and response, which is consistent with the nonlinear baseline model. IRF is described like the equation (9).

$$IRF(h, \nu_t, w_{t-1}) = E[N_{a,t+h} | \nu_t, w_{t-1}] - E[N_{a,t+h} | w_{t-1}] \quad (9)$$

Where  $\nu_t$  is current shock on  $f_{a,t}$ ,  $w_{t-1}$  is history and  $h$  is the predictive period ( $h=1, \dots, 11$ ).

### 3.2.2 Daily Impulse response analysis

Daily impulse response analysis is a further developed analysis on the basis of monthly analysis. Due to the frequency, the volatility of financial market index, traders' connectedness measures and traders' actual daily net trading volumes can be linked with daily analysis. The linkage of those three variables can give us the clue to understand how the financial market volatility spills over. If the event of market volatility increase occurs in financial market, it might cause the change of the network structures in capital market. The massive change of a certain trader's connectedness measure can make some traders to trade abnormally. Then, the abnormal trading can cause the other traders' subsequent abnormal trading. I define this chain link as 3 phased volatility spill over framework and analyse each phase with nonlinear impulse response analysis.

3 phased volatility spill over, can be modelled with 3 different vectors. First of all, I define the vector of each stage.  $D_{a,t}$  is the vector combined with traders' daily connectedness measure and a financial index's volatility, as  $D_{a,t} = [d_{t(ind),m(su),t}, \dots, d_{t(for),m(fxd),t}, fd_{a,t}]'$ .  $d_{t(i),m(j),t}$  is the daily connectedness measure of trader  $i$  from market  $j$ .  $fd_{a,t}$  ( $a=1,2,3,4,5$ ) is daily volatility of KOSPI ( $a=1$ ), KRW/USD ( $a=2$ ), S&P ( $a=3$ ), NIKKEI ( $a=4$ ), and HANGSENG ( $a=5$ ).<sup>9</sup>

---

<sup>9</sup>KOSPI is the index to reflect the risk of Korean financial and economic situation the most and currency rate is very sensitive index due to Korea's export-driven economic characteristic. S&P is one of the most representative index for global financial risk. NIKKEI and HANGSENG are chosen for Korean economy is closely linked with Japanese and Chinese economy and the volatility of them can be the risk driver to Korean financial market. By the data provided by Korea Customs service Korea's biggest trade partner countries are US, China and Japan excluding oil exporting countries. I use each index's daily volatility over previous 30 days which is consistent with the window to estimate traders' connectedness measures.

$T_{b,t}$  is the vector composed of traders' daily net trading volume and a trader's daily connectedness measure. It can be defined as  $T_{b,t} = [x_{t(ind),m(su),t}, \dots, x_{t(for),m(fxd),t}, d_{b,t}]'$ .  $x_{t(i),m(j),t}$  is the daily net trading volume of trader  $i$  from market  $j$ .  $d_{b,t}$  is the connectedness measure of trader  $b$ , which has the biggest response at the shock of financial volatility at first phase.

The last vector is  $X_t$ , which is traders' trading volume and defined before, as  $X_t = (x_{ind,su,t}, x_{bank,su,t}, \dots, x_{gov,fxd,t}, x_{for,fxd,t})$ . With those three vectors, simple VAR model can be built like equation (10), (11), (12).

$$D_{a,t+1} = \phi_{d1}(D_{a,t}) + \varepsilon_t^{D,a} \quad (10)$$

$$T_{b,t+1} = \phi_{d2}(T_{b,t}) + \varepsilon_t^{T,b} \quad (11)$$

$$X_{t+1} = \phi_{d3}(X_t) + \varepsilon_t^X \quad (12)$$

Where  $\phi_{d1}$ ,  $\phi_{d2}$  and  $\phi_{d3}$  are nonlinear functions which Gaussian kernel is applied. The dimensions of  $D_t$ ,  $T_t$  and  $X_t$  are relatively  $41 \times 1$ ,  $41 \times 1$  and  $40 \times 1$ . In  $D_t$  and  $T_t$ , one different entries which are relatively  $fd_{a,t}$  and  $d_{b,t}$ , is inserted in the vector.

Based on those three simple VAR models, three nonlinear impulse response functions can be defined (equations (13),(14) and (15)) They are basically same with monthly IRF following Koop et al. (1996). The strategy to investigate the channel of market volatility spill over is given below. First of all, assuming the shock is given at one of the financial index's volatility ( $a$ ), the responses of the most sensitive traders' connectedness measures are identified with IRF1. Secondly, if there is a shock on the most sensitive traders' connectedness measures in phase 1, which is ( $b$ ), IRF2 shows which traders trade abnormally. Lastly, given the shock at abnormal traders' daily net trading volume in phase 2, which is ( $c$ ), the responses of traders' daily net trading volumes are observed.



With these three impulse response functions, financial index's volatility, traders' daily connectedness measures and traders' actual daily net trading volume can be interlinked.

$$IRF1(h, \nu_t^{D,a}, w_{t-1}^{D,a}) = E[D_{a,t+h} | \nu_t^{D,a}, w_{t-1}^{D,a}] - E[D_{a,t+h} | w_{t-1}^{D,a}] \quad (13)$$

$$IRF2(h, \nu_t^{T,b}, w_{t-1}^{T,b}) = E[T_{b,t+h} | \nu_t^{T,b}, w_{t-1}^{T,b}] - E[T_{b,t+h} | w_{t-1}^{T,b}] \quad (14)$$

$$IRF3(h, \nu_t^{X,c}, w_{t-1}^{X,c}) = E[X_{c,t+h} | \nu_t^{X,c}, w_{t-1}^{X,c}] - E[X_{c,t+h} | w_{t-1}^{X,c}] \quad (15)$$

This econometric modelling can be interpreted as below. If there is a shock in financial index, traders' expectation forecasting on other traders' reaction needs to be updated. In this process the influence of each trader to others changes and the network structure among them is reformed. As the sensitivity of each trader's network measure differs, some traders' connectedness measures increase but others' decrease. Given the change of network measures, several particular traders react to the influential traders more than others. In addition, if some traders react abnormally to central traders after the shock in financial index, some traders react to them susceptibly. In this spill over process, the network structure, which plays an important role for the central traders, becomes the channel through which the market volatility propagates.

## 4 Data

I analyse eight types of traders' daily net trading volume from five different Korean financial markets, which are stock (KOSPI), stock derivative (KOSPI200 futures), bond (all listed bonds), bond derivative (Korean Treasury Bond (3yrs maturity) futures), and FX derivative (KRW/USD futures) markets. The period which the data is collected, is

Table 3: Descriptive statistics of traders' daily net trading volume

|                  |          | IND   | BANK  | FI    | CIS   | OTH   | INS    | GOV    | FOR   |
|------------------|----------|-------|-------|-------|-------|-------|--------|--------|-------|
| Stock            |          |       |       |       |       |       |        |        |       |
|                  | Mean     | -0.01 | -0.01 | 0.02  | -0.08 | 0.00  | 0.02   | 0.09   | -0.02 |
|                  | Max      | 1.00  | 0.79  | 0.97  | 1.00  | 0.48  | 0.87   | 1.00   | 1.00  |
|                  | Min      | -1.00 | -1.00 | -0.94 | -1.00 | -0.67 | -0.67  | -1.00  | -1.00 |
|                  | Sted     | 0.60  | 0.11  | 0.23  | 0.44  | 0.04  | 0.13   | 0.30   | 0.61  |
|                  | Skewness | -0.04 | -2.51 | -0.31 | -0.01 | -2.14 | 0.04   | -0.20  | -0.01 |
|                  | Kurtosis | -1.28 | 24.70 | 2.47  | -0.65 | 49.42 | 4.44   | 0.94   | -1.30 |
| Stock derivative |          |       |       |       |       |       |        |        |       |
|                  | Mean     | 0.00  | 0.00  | 0.00  | 0.01  | 0.00  | 0.00   | 0.00   | -0.02 |
|                  | Max      | 1.00  | 0.67  | 1.00  | 1.00  | 0.41  | 0.88   | 0.94   | 1.00  |
|                  | Min      | -1.00 | -0.59 | -1.00 | -1.00 | -0.34 | -0.64  | -1.00  | -1.00 |
|                  | Sted     | 0.50  | 0.09  | 0.42  | 0.40  | 0.03  | 0.11   | 0.17   | 0.73  |
|                  | Skewness | 0.00  | 0.19  | -0.02 | 0.00  | 1.23  | 0.54   | -0.10  | 0.04  |
|                  | Kurtosis | -0.98 | 8.49  | -0.52 | -0.17 | 44.44 | 8.39   | 4.90   | -1.60 |
| Bond             |          |       |       |       |       |       |        |        |       |
|                  | Mean     | 0.04  | 0.15  | -0.85 | 0.28  | 0.02  | 0.11   | 0.16   | 0.09  |
|                  | Max      | 0.44  | 0.91  | 0.97  | 1.00  | 0.51  | 0.66   | 0.88   | 0.86  |
|                  | Min      | -0.22 | -1.00 | -1.00 | -0.74 | -0.56 | -1.00  | -0.86  | -1.00 |
|                  | Sted     | 0.06  | 0.29  | 0.25  | 0.23  | 0.06  | 0.14   | 0.17   | 0.17  |
|                  | Skewness | 1.40  | -0.76 | 2.87  | -0.17 | -0.33 | -0.71  | -0.02  | -0.03 |
|                  | Kurtosis | 6.33  | 0.91  | 10.26 | 0.86  | 16.78 | 4.01   | 1.78   | 5.58  |
| Bond derivative  |          |       |       |       |       |       |        |        |       |
|                  | Mean     | 0.00  | -0.01 | -0.01 | 0.00  | 0.00  | 0.00   | 0.00   | 0.03  |
|                  | Max      | 0.89  | 1.00  | 1.00  | 0.90  | 0.33  | 0.96   | 0.66   | 1.00  |
|                  | Min      | -0.90 | -1.00 | -1.00 | -0.93 | -0.36 | -0.87  | -0.59  | -1.00 |
|                  | Sted     | 0.14  | 0.57  | 0.59  | 0.20  | 0.02  | 0.16   | 0.10   | 0.65  |
|                  | Skewness | 0.20  | 0.04  | 0.04  | -0.10 | 0.31  | 0.17   | -0.20  | -0.05 |
|                  | Kurtosis | 7.20  | -1.15 | -1.29 | 2.25  | 70.36 | 6.02   | 4.07   | -1.35 |
| FX derivative    |          |       |       |       |       |       |        |        |       |
|                  | Mean     | 0.00  | 0.04  | 0.02  | -0.06 | 0.00  | 0.00   | 0.00   | 0.00  |
|                  | Max      | 1.00  | 1.00  | 1.00  | 1.00  | 0.70  | 0.75   | 0.34   | 1.00  |
|                  | Min      | -1.00 | -1.00 | -1.00 | -1.00 | -0.57 | -0.61  | -0.42  | -1.00 |
|                  | Sted     | 0.47  | 0.56  | 0.48  | 0.34  | 0.07  | 0.04   | 0.01   | 0.55  |
|                  | Skewness | -0.01 | -0.04 | 0.00  | -0.11 | 0.31  | -0.70  | -7.65  | 0.01  |
|                  | Kurtosis | -0.41 | -1.04 | -0.82 | 1.37  | 13.97 | 101.77 | 827.08 | -1.01 |

[Note]

IND = Individual trader, BANK = Bank, FI = Financial investment(mainly securities companies)

CIS = Collective Investment Scheme, OTH = Others (small financial companies)

INS = Insurance companies, GOV = Government, FOR = Foreign investment

from 2006 to 2015. The descriptive statistic is given on table 3.<sup>10</sup>

Daily net trading volume is defined as a trader's net selling or buying during a day. I standardize all daily net trading volume dividing with a half of the summation of all traders' absolute daily net trading volume. With this process, the distortion of the trader, the day, and the market with massive volumes can be avoided. All daily net trading volumes are stationary.

The values of expectation forecast on a trader's daily net trading volume on next day (hereafter "expectation forecast") are estimated with LSTM, which is one of the most popularly used machine learning methods in time series data prediction.

Financial indexes and macro variables are also used to investigate the relations of traders' connectedness measures and the volatility of financial market or macro economic conditions. Financial indexes are selected based on the trade dependence of Korean economy.

## 5 Monthly result

Monthly network structures in capital markets are estimated and impulse response analysis is implemented with those in this section. First, I start with forecasting of every trader's daily net trading volume on next day. Every daily net trading volume is forecasted with LSTM as mentioned previous section. Once the forecasting is done, granger causality matrix is estimated for every 24 months with moving windows method. The entry of each granger causality matrix is logarithmic ratio of restricted model's forecasted error over unrestricted model's forecasted error. The only difference between restricted model and unrestricted model is whether the forecasted daily net trading volume on a trader is included as an independent variable.

Then, the connectedness measure of each trader which is similar with degree centrality, is obtained with the causality matrix. Consequently traders' OUT/IN measures are

---

<sup>10</sup>I use same data with Hwang (2018a), Hwang (2018b) for comparison purpose.

relatively acquired. Before calculating connectedness measures, all granger causality matrix are tested for the statistical significance with bootstrapping method. If the entry of granger causality matrix is statistically significant, it is transformed to 1 and otherwise to 0. After all entries are converted to 1 or 0, granger causality matrix becomes binary adjacency matrix, which represent the network structure. OUT/IN connectedness measures can be obtained by adjacency matrix easily.<sup>11</sup>

All traders' monthly connectedness measures are compared and influential traders are identified. However, only with the connectedness measures, it is hard to assess the impacts of financial or macro economic variables on traders' connectedness measures.

Therefore, impulse response analysis is also implemented which is an effective method to see the changes of variables at the shock of a certain variable. Here, given the shock of five financial indexes and five macro variables, the change of each trader's OUT/IN connectedness measure is analyzed.

## 5.1 Network structure with expectation forecast

Several particular traders' monthly average OUT connectedness measures have explicitly higher values than others, while all monthly average IN connectedness measures are shown to be similarly low, as seen in figure 1. They are foreign investors(FOR) in stock, stock derivative, bond derivative and FX derivative market, individual investors (IND) in stock and FX derivative market, BANK in bond derivative and FX derivative market and financial investment (FI) in bond derivative market. The average values of all IN connectedness measures are within the range of 0.06 and 0.14.

This result strongly supports the evidence of influential traders in capital markets. Traders refer to their expectation on some influential traders' trading on next day. Foreign investors (FOR) in all markets but bond market, individual investors (IND) in stock and FX derivative markets seem to have strong impacts on other traders. This is also consistent

---

<sup>11</sup>Row sum of the adjacency is a trader's OUT connectedness measures and column sum of the adjacency matrix is a traders' IN connectedness measure.

with the results of previous literature (Hwang (2018a) and Hwang (2018b)).

Despite of the meaningful result, it is still hard to have a practical implication under monthly setup. Since trading data is fundamentally daily and most of financial data is daily base, the meaningful connection of traders' connectedness measure and financial volatility is difficult with monthly analysis. Nonetheless, it can be linked with monthly macro economic data significantly.

Figure 1: Average monthly OUT/IN connectedness measures

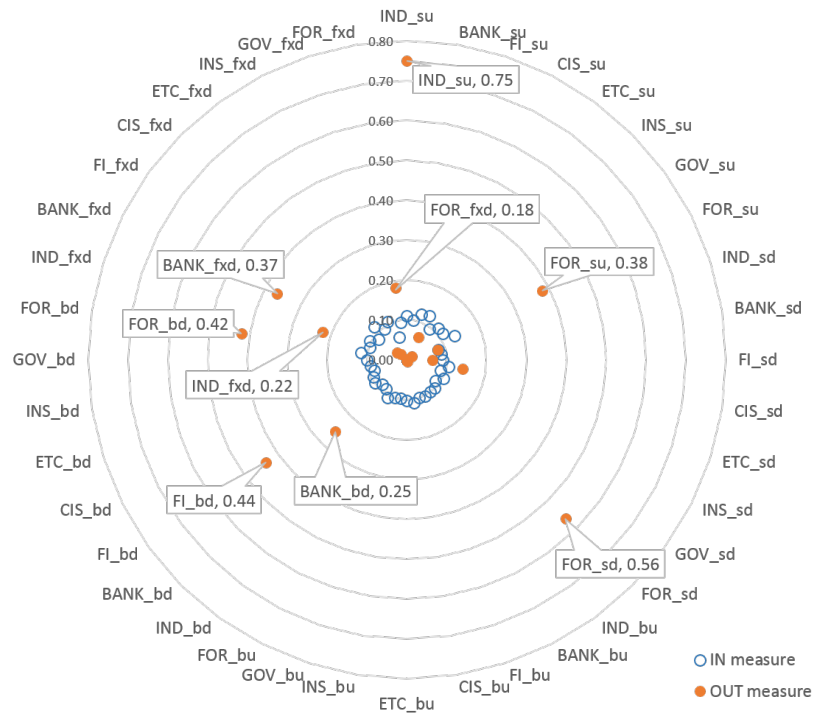

**[Notes]**

1. Traders' monthly OUT and IN measures are averaged during the investigated period.
2. OUT degree is orange circle and IN degree is white circle.
3. Trader  
IND = Individual trader, BANK = Bank, FI = Financial investment(securities companies)  
CIS = Collective Investment Scheme, OTH = others (small financial companies)  
INS = Insurance companies, GOV = Government, FOR = Foreign investment
4. Market  
su = Stock, sd = Stock derivative, bu = Bond, bd = Bond derivative, fxd = FX derivative

Table 4: Impulse response analysis with monthly OUT connectedness measures

|         |          | Positive response |              |              | Negative response |              |              |  |
|---------|----------|-------------------|--------------|--------------|-------------------|--------------|--------------|--|
|         |          | 1st               | 2nd          | 3rd          | 1st               | 2nd          | 3rd          |  |
|         |          | Positive shock    |              |              |                   |              |              |  |
| Finance | Kospi    | $GOV_{fxd}$       | $CIS_{fxd}$  | $GOV_{bu}$   | $CIS_{su}$        | $FOR_{su}$   | $OTH_{bd}$   |  |
|         | Krw/usd  | $IND_{su}$        | $BANK_{fxd}$ | $FI_{bd}$    | $IND_{fxd}$       | $FOR_{su}$   | $FOR_{sd}$   |  |
|         | S&P      | $BANK_{fxd}$      | $IND_{su}$   | $FI_{bd}$    | $IND_{fxd}$       | $FOR_{sd}$   | $FOR_{su}$   |  |
|         | Nikkei   | $FI_{bd}$         | $BANK_{fxd}$ | $IND_{su}$   | $IND_{fxd}$       | $FOR_{sd}$   | $FOR_{su}$   |  |
|         | Hangseng | $BANK_{fxd}$      | $IND_{su}$   | $CIS_{sd}$   | $IND_{fxd}$       | $FOR_{su}$   | $FOR_{sd}$   |  |
| Macro   | Crt.at   | $FOR_{sd}$        | $IND_{fxd}$  | $FI_{sd}$    | $IND_{sd}$        | $BANK_{fxd}$ | $CIS_{su}$   |  |
|         | C&F.at   | $FOR_{sd}$        | $IND_{fxd}$  | $FI_{sd}$    | $BANK_{fxd}$      | $IND_{sd}$   | $IND_{su}$   |  |
|         | Inf.     | $BANK_{fxd}$      | $IND_{su}$   | $IND_{sd}$   | $FOR_{sd}$        | $FI_{sd}$    | $FOR_{bd}$   |  |
|         | Nepl     | $BANK_{bd}$       | $FOR_{fxd}$  | $BANK_{fxd}$ | $IND_{fxd}$       | $FOR_{su}$   | $FOR_{bd}$   |  |
|         | B.int    | $IND_{sd}$        | $BANK_{fxd}$ | $FI_{fxd}$   | $FOR_{sd}$        | $FI_{sd}$    | $BANK_{bd}$  |  |
|         |          | Negative shock    |              |              |                   |              |              |  |
| Finance | Kospi    | $GOV_{fxd}$       | $CIS_{fxd}$  | $GOV_{bu}$   | $CIS_{su}$        | $FOR_{su}$   | $OTH_{bd}$   |  |
|         | Krw/usd  | $IND_{fxd}$       | $FOR_{su}$   | $FOR_{sd}$   | $IND_{su}$        | $BANK_{fxd}$ | $FI_{bd}$    |  |
|         | S&P      | $IND_{fxd}$       | $FOR_{sd}$   | $FOR_{su}$   | $BANK_{fxd}$      | $IND_{su}$   | $FI_{bd}$    |  |
|         | Nikkei   | $IND_{fxd}$       | $FOR_{sd}$   | $FOR_{su}$   | $FI_{bd}$         | $BANK_{fxd}$ | $IND_{su}$   |  |
|         | Hangseng | $IND_{fxd}$       | $FOR_{su}$   | $FOR_{sd}$   | $BANK_{fxd}$      | $IND_{su}$   | $CIS_{sd}$   |  |
| Macro   | Crt.at   | $IND_{sd}$        | $BANK_{fxd}$ | $CIS_{su}$   | $IND_{fxd}$       | $FOR_{sd}$   | $FI_{sd}$    |  |
|         | C&F.at   | $IND_{sd}$        | $BANK_{fxd}$ | $IND_{su}$   | $FOR_{sd}$        | $IND_{fxd}$  | $FI_{sd}$    |  |
|         | Inf.     | $FOR_{sd}$        | $FI_{sd}$    | $FOR_{bd}$   | $BANK_{fxd}$      | $IND_{su}$   | $IND_{sd}$   |  |
|         | Nepl     | $IND_{fxd}$       | $FOR_{su}$   | $FOR_{bd}$   | $BANK_{bd}$       | $FOR_{fxd}$  | $BANK_{fxd}$ |  |
|         | B.int    | $FOR_{sd}$        | $FI_{sd}$    | $BANK_{bd}$  | $BANK_{fxd}$      | $IND_{sd}$   | $FI_{fxd}$   |  |

[Note]

1. The responses of traders' OUT connectedness measures are present at the shock financial / macro variables.

For each shock, the traders with top 3 positive(negative) are shown.

2. Financial variables are the monthly volatility of KOSPI, KRW/USD, S&P, NIKKEI, HANGSENG.

3. Macro economic indexes are monthly Current account(Crt.at), Capital and financial account(C&F.at), Inflation rate(Inf.), Unemployment rate(Nepl), and Base interest rate(B.int).

4. Trader

IND = Individual trader, BANK = Bank, FI = Financial investment, CIS = Collective Investment Scheme, OTH = others, INS = Insurance companies, GOV = Government, FOR = Foreign investment

6. Market

$su$  = stock,  $sd$  = Stock derivative,  $bu$  = Bond,  $bd$  = Bond derivative,  $fxd$  = FX derivative

## 5.2 Impulse response analysis

I consider both positive and negative shock at the same time with impulse response analysis. In case of the volatility of financial market, positive shock can be more influential to other variables. By contrast, a negative shock of macro variable such as current account, can make a significant impacts on other variables. The responses of network measures are shown not to last for over two periods. The responses are present at the first period and fade away later. The directions and scales of responses of traders' connectedness measures, however, contrast evidently at the same shock. Thus, I focus on the top 3 positive and negative responses at each positive and negative shock of financial and macro economic variable.

The most three sensitive responses of traders' OUT connectedness measures at the shock on financial and macro economic variables are present, as seen on table 4. OUT connectedness measures, by definition, are the extent to which all traders use their expectation forecast on the trader's trading volume on next day for their trading reference. In other words, it is the trader's influence to all other market participants. Thus, if a traders' OUT connectedness measure increases (decreases) at a shock, it is interpreted that the shock causes that trader to be more influential (uninfluential).

An important finding with OUT connectedness measures is the parallel relation of shock and response, which is that the positive responses at a positive shock is similar with negative responses at a negative shock. The parallel relation is also found at negative responses at a positive shock and positive responses at a negative shock. It shows that traders' connectedness measures are consistently linked with financial and macro economics variables regardless of the direction of shock.

Several close relations with traders and foreign financial indexes including local FX market, are found at table 4. When the volatility of KRW/USD and foreign financial market indexes increases, BANK in FX derivative market, individual investors (IND) in stock market and financial investment (FI) in bond derivative market become more influential. On the contrary, the negative reactors at the same positive shock seem to be more evident.

Individual investors (IND) in FX derivative market, and foreign investors (FOR) in stock and stock derivative market lose their influence.

These results give significant implications. First, when international market turns volatile, the importance of BANK's trading in FX derivative market increases, which can result from bank's monopolistic role as a mediator in foreign exchange market.<sup>12</sup> Second, foreign investors' (FOR) influence in domestic market decreases when foreign financial market volatility increases. This means that at least foreign investors are not the main driver to contribute to market volatility increase during crisis time, and that they are more likely to be contrarian investors than trend followers, which is consistent with the results of Hwang (2018a) and Hwang (2018b). The other is about the trait of individual investors (IND). When global financial market is unstable, they play an unstabilizing role in domestic stock market but become inactive in FX derivative market.

There are two opposite patterns of responses at the shock of macro economic variables. Macro economic variables can be divided into good and bad signs unlike the financial market volatility. The good signs are the increase of balance of payment accounts and the decrease of inflation, unemployment rate and base interest rate. By contrary, the bad signs are the contraction of balance of payment account and the rise of inflation, unemployment rate and base interest rate.

BANK in FX derivative markets actively response to the bad signs, while foreign investors (FOR) in stock derivative markets react susceptibly to good signs. BANK's increased importance in FX derivative market at the bad times is in line with its influence increase at the turmoil in the international financial markets. However, foreign investors' increased influence in stock derivative market at an economically good time seems reasonable and is consistent with previous literature in that foreign investors' investment increase is closely related to economic fundamentals.

IN connectedness means how much a trader refer their expectation forecast of other traders' trading volume on next day. Impulse response analysis result with IN connected-

---

<sup>12</sup>By Korean law, "Foreign exchange transactions Act", foreign exchange financial transaction should be implemented only through Korean commercial banks.



Table 5: Impulse response analysis with monthly IN connectedness measures

|         |          | Positive response |             |             | Negative response |             |             |  |
|---------|----------|-------------------|-------------|-------------|-------------------|-------------|-------------|--|
|         |          | 1st               | 2nd         | 3rd         | 1st               | 2nd         | 3rd         |  |
|         |          | Positive shock    |             |             |                   |             |             |  |
| Finance | Kospi    | $GOV_{fxd}$       | $CIS_{fxd}$ | $GOV_{bu}$  | $CIS_{su}$        | $FOR_{su}$  | $OTH_{bd}$  |  |
|         | Krw/usd  | $IND_{bu}$        | $GOV_{su}$  | $INS_{bu}$  | $CIS_{su}$        | $FOR_{su}$  | $OTH_{bd}$  |  |
|         | S&P      | $IND_{bu}$        | $CIS_{fxd}$ | $GOV_{su}$  | $CIS_{su}$        | $FOR_{su}$  | $OTH_{bd}$  |  |
|         | Nikkei   | $IND_{bu}$        | $GOV_{su}$  | $IND_{bd}$  | $CIS_{su}$        | $OTH_{su}$  | $FOR_{su}$  |  |
|         | Hangseng | $CIS_{fxd}$       | $GOV_{su}$  | $GOV_{bu}$  | $CIS_{su}$        | $OTH_{bd}$  | $FOR_{su}$  |  |
| Macro   | Crt.at   | $OTH_{bd}$        | $INS_{su}$  | $FI_{su}$   | $OTH_{su}$        | $CIS_{fxd}$ | $GOV_{bu}$  |  |
|         | C&F.at   | $OTH_{bd}$        | $INS_{su}$  | $FI_{su}$   | $OTH_{su}$        | $CIS_{fxd}$ | $GOV_{bu}$  |  |
|         | Inf.     | $CIS_{fxd}$       | $GOV_{bu}$  | $BANK_{su}$ | $OTH_{bd}$        | $CIS_{su}$  | $FI_{su}$   |  |
|         | Nepl     | $FI_{su}$         | $FI_{bu}$   | $BANK_{bu}$ | $GOV_{fxd}$       | $FOR_{bd}$  | $BANK_{su}$ |  |
|         | B.int    | $GOV_{fxd}$       | $GOV_{bu}$  | $CIS_{bu}$  | $OTH_{bd}$        | $FI_{su}$   | $INS_{bu}$  |  |
|         |          | Negative shock    |             |             |                   |             |             |  |
| Finance | Kospi    | $GOV_{fxd}$       | $CIS_{fxd}$ | $GOV_{bu}$  | $CIS_{su}$        | $FOR_{su}$  | $OTH_{bd}$  |  |
|         | Krw/usd  | $CIS_{su}$        | $OTH_{bd}$  | $FOR_{su}$  | $GOV_{su}$        | $IND_{bu}$  | $INS_{bu}$  |  |
|         | S&P      | $CIS_{su}$        | $FOR_{su}$  | $OTH_{bd}$  | $CIS_{fxd}$       | $IND_{bu}$  | $GOV_{su}$  |  |
|         | Nikkei   | $CIS_{su}$        | $OTH_{su}$  | $FOR_{su}$  | $IND_{bu}$        | $GOV_{su}$  | $IND_{bd}$  |  |
|         | Hangseng | $CIS_{su}$        | $OTH_{bd}$  | $FOR_{su}$  | $CIS_{fxd}$       | $GOV_{su}$  | $GOV_{bu}$  |  |
| Macro   | Crt.at   | $OTH_{su}$        | $CIS_{fxd}$ | $GOV_{bu}$  | $OTH_{bd}$        | $INS_{su}$  | $FI_{su}$   |  |
|         | C&F.at   | $CIS_{fxd}$       | $OTH_{su}$  | $GOV_{bu}$  | $OTH_{bd}$        | $INS_{su}$  | $FI_{su}$   |  |
|         | Inf.     | $OTH_{bd}$        | $CIS_{su}$  | $FI_{su}$   | $CIS_{fxd}$       | $GOV_{bu}$  | $BANK_{su}$ |  |
|         | Nepl     | $GOV_{fxd}$       | $FOR_{bd}$  | $BANK_{su}$ | $FI_{su}$         | $FI_{bu}$   | $BANK_{bu}$ |  |
|         | B.int    | $OTH_{bd}$        | $FI_{su}$   | $INS_{bu}$  | $GOV_{fxd}$       | $GOV_{bu}$  | $CIS_{bu}$  |  |

[Note]

1. The responses of traders' IN connectedness measures are present at the shock financial / macro variables.

For each shock, the traders with top 3 positive(negative) are shown.

2. Financial variables are the monthly volatility of KOSPI, KRW/USD, S&P, NIKKEI, HANGSENG.

3. Macro economic indexes are monthly Current account(Crt.at), Capital and financial account(C&F.at), Inflation rate(Inf.), Unemployment rate(Nepl), and Base interest rate(B.int).

4. Trader

IND = Individual trader, BANK = Bank, FI = Financial investment, CIS = Collective Investment Scheme, OTH = others, INS = Insurance companies, GOV = Government, FOR = Foreign investment

5. Market

$su$  = stock,  $sd$  = Stock derivative,  $bu$  = Bond,  $bd$  = Bond derivative,  $fxd$  = FX derivative

ness measures is present on table 5. It captures the sensitivity of a trader to other traders, which contrasts to independence of a trader. If a traders' IN connectedness measure increase at a shock, it means that the trader receive more influence from other traders. By contrast, when a IN connectedness measure decrease at a shock, the trader trades more independently.

Parallel effect is also found with regard to IN connectedness measures. Positive responses at a positive shock seem very similar with negative responses at a negative shock. At the same time negative responses at a positive shock look similar with positive responses with a negative shock.

The response of traders at the shock of financial variables are divided. Some traders gain more sensitivity such as individual investors (IND) in bond market, government (GOV) in stock market, and collective investment scheme (CIS) in FX derivative market. Others including collective investment scheme (CIS) and foreign investors (FOR) in stock market, by contrast, lose their sensitivity but trade more independently when the financial markets turn to volatile period. This can be an evidence that foreign investors and institutional investors have the superiority in terms of investment information than individual traders.

In case of the shock of macro variable, it is not easy to find evident patterns. The three most sensitive traders, however, are same at the shock of current account and capital and financial account.

The result of monthly impulse response analysis provides the preliminary understanding on the relations of financial/macro variables and traders' connectedness measures. The reactions of traders' connectedness measures to financial and macro variables seem somewhat different. Even among financial variables, the responses of connectedness measures at the shock of domestic and foreign indexes differ. The reactions to foreign indexes and currency rate, however, seem similar. In case of macro variables, the reactions of connectedness measures to the shock of balance of payments seem similar. Yet, other reactions don't look similar. The research on the relations of the specific financial / macro variables and traders' connectedness measures can be studied further in depth.

In spite of those findings, there are still some rooms for more development. First, the feature of network change cannot be explained enough with monthly data. The influence of connectedness measure to real daily net trading volume cannot be also described with above result. Therefore, the investigation with daily data and a wider scope, is done in next section.

## **6 Market volatility spill over channels with daily result**

In this section, daily network structure estimation and impulse response analysis are implemented with a similar fashion with monthly analysis. The analysis with a daily framework has a few benefits compared to monthly analysis. First of all, due to the data frequency, more dynamic changes of network structures including some findings which can be ignored with the monthly analysis framework, can be identified. Secondly, traders' actual trading can be linked with the volatility of financial indexes and traders' connectedness measures in the analysis. This feature enables to investigate traders' connectedness measures as a spill over channel of the financial market volatility. With three consecutive impulse response functions, I model and analyse 3 phased market volatility spill over framework.

### **6.1 Network structure with expectation forecast**

Daily network estimation result looks almost same with monthly result. Several influential traders with higher OUT connectedness measures are found, and all traders' In connectedness measures are similarly low.

An important finding is influential traders under daily setup are almost same with the influential traders under monthly setup. The only difference is that collective investment scheme (CIS) in stock derivative market is added to monthly influential traders.

This result also provides the evidences of the existence of influential traders in capital markets, which can be more supportive due to the more frequent setup. The consistency of the result makes monthly result more reliable at the same time.

Figure 2: Average daily OUT/IN connectedness measures

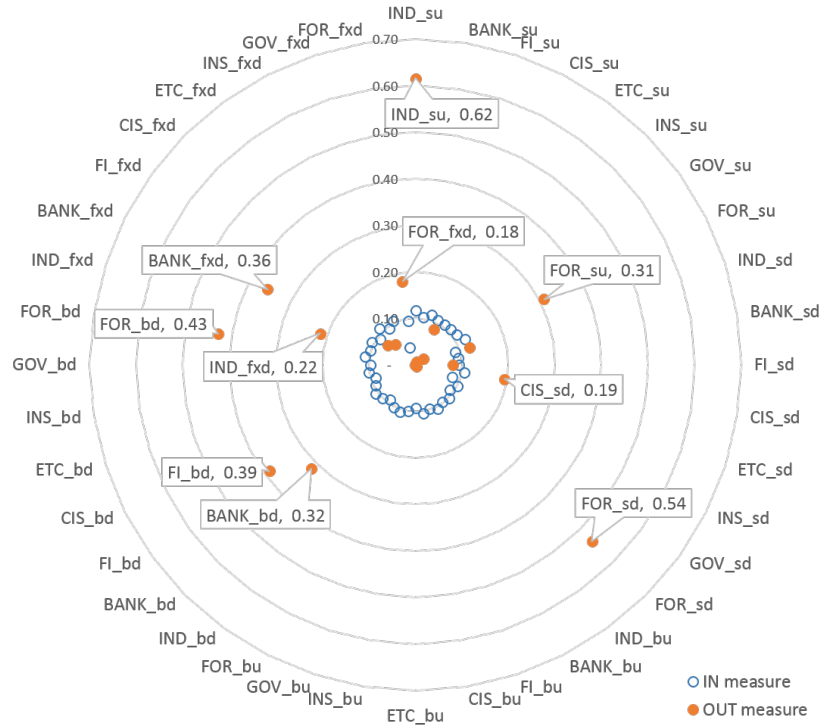

**[Notes]**

1. Traders' daily OUT and IN measures are averaged during the investigated period.
2. OUT degree is orange circle and IN degree is white circle.
3. Trader  
IND = Individual trader, BANK = Bank, FI = Financial investment(securities companies)  
CIS = Collective Investment Scheme, OTH = others (small financial companies)  
INS = Insurance companies, GOV = Government, FOR = Foreign investment
4. Market  
su = Stock, sd = Stock derivative, bu = Bond, bd = Bond derivative, fxd = FX derivative

## 6.2 Market volatility spill over channels

The spill over of financial market volatility throughout traders' connectedness measures and trading activities is investigated in this section. One of the main benefits of network

studies in finance is to assess systemic risk, which is not the risk on a single entity or a contract, but the risk on the entire system or the market. In addition, the spill over of the risk can be assessed with the method of network studies, if there is a certain type of risk in the entire system. The inter-linkage between the agents in the system can function as a map when the risk spill over within the system. The inter-connections among traders are investigated to play a role as a volatility spill over channel.

### **6.3 Framework**

Financial market volatility spill over channels are investigated with 3-phased framework which are composed of financial indexes, traders' connectedness measures and daily net trading volumes. First phase is from financial market indexes to traders' connectedness (network) measures like figure 3. If there is an abnormal shock in 5 different financial indexes relatively, the reactions of traders' connectedness measures are observed. Here I use OUT connectedness (network) measure, since it captures a trader's influence to others. Given the stressed situations, some traders become central within the network in the capital markets. Second phase is from traders' connectedness measures to traders' daily net trading volume. If a trader becomes central within the network, some traders' trading behaviours are more sensitive to the shock on the connectedness measure of the central trader. Last phase is from traders' daily net trading volumes to traders' daily net trading volumes. Traders react differently to other traders' net trading volumes changes. In particular, there would be some specific patterns of reactions to a certain shock of daily net trading volumes.

I focus on the most sensitive three connectedness measures and traders' net trading volumes for the simplicity of analysis at the second and third phases, . For example, if there is an unexpected shock in KOSPI, the most sensitive three connectedness measures are investigated. And then given the shocks on those connectedness measures, the most subsequent three traders are identified. With the same fashion, under the shock of those

top three traders' daily net trading volumes, the most three sensitive traders' net trading volumes are also investigated.

Figure 3: 3 phased market volatility spill over structure

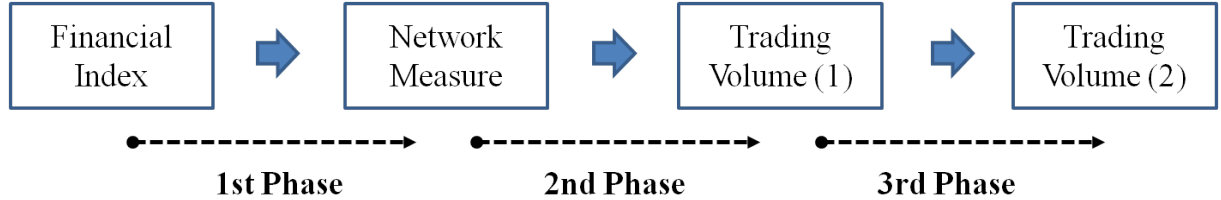

## 6.4 Result of 1st phase

Evidently, the responses of connectedness measures at first phase are almost same regardless of the source of shock, as seen on table 6. Three most sensitive connectedness measures to all financial indexes are individual investors (IND) in stock market, collective investment scheme (CIS) in FX derivative market and collective investment scheme (CIS) in stock market. This means that when there is an unexpected increase in financial indexes, those three trader's connectedness measures increase. The result is also consistent with the common sense in capital market. Individual investors (IND) are usually overly sensitive to market index's movement and mutual funds (CIS) also move together with index in general.

In terms of negative responses, the reactions of traders' connectedness measures seem comparable to positive responses. The most sensitive negative responses at the shocks in 5 financial indexes are almost same. Exceptionally BANK in FX derivative market replaces foreign investors (FOR) in stock market at the shock of NIKKEI. Three top negative reactions are found in foreign investors (FOR) in bond derivative market, individual investors (IND) in FX derivative market, and foreign investors (FOR) in stock market.

The implication is that market participants do not refer their expectation on foreign investors' trading in bond derivative and stock market when the market is volatile. This

Table 6: Connectedness measure changes at the shock of financial indexes

|          |     | Shock at the financial market volatility |             |             |              |             |
|----------|-----|--|-------------|-------------|--------------|-------------|
|          |     | Kospi                                    | Krw/usd     | S&P         | Nikkei       | Hangseng    |
| Positive | 1st | $IND_{su}$                               | $CIS_{fxd}$ | $CIS_{fxd}$ | $CIS_{fxd}$  | $CIS_{fxd}$ |
|          | 2nd | $CIS_{fxd}$                              | $IND_{su}$  | $IND_{su}$  | $IND_{su}$   | $IND_{su}$  |
|          | 3rd | $CIS_{su}$                               | $CIS_{su}$  | $CIS_{su}$  | $CIS_{su}$   | $CIS_{su}$  |
| Negative | 1st | $FOR_{bd}$                               | $FOR_{bd}$  | $FOR_{bd}$  | $FOR_{bd}$   | $IND_{fxd}$ |
|          | 2nd | $IND_{fxd}$                              | $IND_{fxd}$ | $IND_{fxd}$ | $IND_{fxd}$  | $FOR_{bd}$  |
|          | 3rd | $FOR_{su}$                               | $FOR_{su}$  | $FOR_{su}$  | $BANK_{fxd}$ | $FOR_{su}$  |

[Note]

1. Top 3 positive(negative) responses of traders' OUT connectedness measure at financial variable's shock.
2. Financial variables are the daily volatility of KOSPI, KRW/USD, S&P, NIKKEI, and HANGSENG.
3. Trader  
IND = Individual trader, BANK = Bank, FI = Financial investment, CIS = Collective Investment Scheme,  
OTH = others, INS = Insurance companies, GOV = Government, FOR = Foreign investment
4. Market  
 $su$  = stock,  $sd$  = Stock derivative,  $bu$  = Bond,  $bd$  = Bond derivative,  $fxd$  = FX derivative

result supports the findings of previous literature (Hwang (2018a), Hwang (2018b)), which foreign investors lose their influence during crisis time and trader independently. Thus, the common conception which foreign investors destabilize financial market during crisis, needs to be reconsidered and over-concern of media on foreign investors' exit during crisis time seems to lack the evidences.

## 6.5 Result of 2nd phase

The most sensitive 3 traders' daily net trading volumes in 2nd phase at the shock of influential traders' connectedness measures can be found in diverse markets, which means that financial market volatility can be spilled over to different markets through central traders, as seen in table 7. I assume there is a positive shock at top three positive reactive traders and a negative shock at top three negatively responsive traders in phase one. For instance, when the shock was given at the connectedness measure of individual investors (IND) in stock market, the traders in FX derivative, bond, and bond derivative market react more actively.

Two interesting phenomena are found at the positive shock in addition. One is that

Table 7: Trading volume changes at the shock of OUT connectedness measure

|          |     | Shock at traders' connectedness measures |              |             |                |              |              |
|----------|-----|--|--------------|-------------|----------------|--------------|--------------|
|          |     | Positive Shock                           |              |             | Negative Shock |              |              |
|          |     | $IND_{su}$                               | $CIS_{fxd}$  | $CIS_{su}$  | $FOR_{bd}$     | $IND_{fxd}$  | $FOR_{su}$   |
| Positive | 1st | $CIS_{fxd}$                              | $BANK_{fxd}$ | $FOR_{bd}$  | $IND_{su}$     | $BANK_{fxd}$ | $CIS_{su}$   |
|          | 2nd | $BANK_{bu}$                              | $FOR_{su}$   | $BANK_{bu}$ | $CIS_{sd}$     | $IND_{su}$   | $CIS_{fxd}$  |
|          | 3rd | $FI_{bd}$                                | $FI_{su}$    | $IND_{su}$  | $FI_{fxd}$     | $CIS_{sd}$   | $FOR_{fxd}$  |
| Negative | 1st | $BANK_{fxd}$                             | $CIS_{su}$   | $CIS_{su}$  | $FOR_{su}$     | $FOR_{su}$   | $FOR_{su}$   |
|          | 2nd | $INS_{bu}$                               | $CIS_{fxd}$  | $INS_{bu}$  | $IND_{sd}$     | $FOR_{fxd}$  | $BANK_{fxd}$ |
|          | 3rd | $FI_{fxd}$                               | $GOV_{su}$   | $BANK_{bd}$ | $IND_{fxd}$    | $IND_{fxd}$  | $FOR_{bu}$   |

[Note]

1. Top 3 positive(negative) responses of traders' daily net trading at shock of OUT connectedness measure .
2. The most responsive traders are 6 traders at table 6.  
- positive (negative) shock is given to positively (negatively) responsive trader.
3. Trader  
IND = Individual trader, BANK = Bank, FI = Financial investment, CIS = Collective Investment Scheme, OTH = others, INS = Insurance companies, GOV = Government, FOR = Foreign investment
4. Market  
 $su$  = stock,  $sd$  = Stock derivative,  $bu$  = Bond,  $bd$  = Bond derivative,  $fxd$  = FX derivative

Collective investment scheme (CIS) and BANKs in FX derivative market respond in opposite direction. CIS have a positive response and BANKs have a negative reaction at the shock on individual investors (IND) in stock market, while at the shock on CIS in FX derivative market, BANKs are shown to respond positively and CIS are observed to react negatively. The other is that, when there is a positive shock in CIS in FX derivative or stock market, their daily net trading volumes react negatively. It means that mutual funds reduce their position when their influence in capital market increases.

Market volatility spill over to diverse markets are also observed in case of negative shock on traders' connectedness measures. The shock in bond derivative market can be spread to stock, stock derivative, and FX derivative market. The responses of foreign investors (FOR) at negative shock need to be discussed more in particular. First, when there is a negative shock in the connectedness measure in foreign investors (FOR) in bond derivative and stock market, and individual investors (IND) in FX derivative market relatively, foreign investors in stock market sell. This means that, when there is an event such as financial market volatility increase, foreign investors' could sell their stocks while their connectedness measures in each financial market decrease at the same time.



A strong co-movements of foreign investors (FOR) in different markets, then, are found in addition. Given the shock on individual investors (IND) in FX derivative market, foreign investors (FOR) in stock and FX derivative market decrease their net trading volumes. And in case of the shock on foreign investors (FOR) in stock market, foreign investors (FOR) in stock and bond market sell their securities as well.

## 6.6 Result of 3rd phase

In 3rd phase strong evidences of "auto correlation"<sup>13</sup> are found, which means that the most sensitive response is same with the origin of shock, regardless that the shock is positive or negative. (table 8) Once a shock is given to the most sensitive traders' daily net trading volumes in 2nd phase, first positive responses of the positive shocks are found in CIS in FX derivative market, BANK in FX derivative market and FOR in bond derivative market.

The trader which has a sensitive response at the shock of his/her own can be interpreted to have similar trading pattern on next day, since in 3rd phase the responses and the shocks are traders' daily net trading volumes.

Auto correlation is also found at a negative shock. The negative reactions at the negative shock in FOR in stock market and BANK in FX derivative market are FOR in stock market and bank in FX derivative market. However, the auto correlation is not found in the net trading volume of FOR in FX derivative market, but instead FOR in FX derivative market trade more given the negative shock of FOR in FX derivative market. IND and CIS in stock market reduce their net trading volume under the negative shock of FOR in FX derivative market, while they increase their net trading volume when FOR in stock market trades less.

---

<sup>13</sup>It could be slightly different from the precise definition of autocorrelation. However, in those cases, autocorrelation of the most sensitive traders can be observed.

Table 8: Trading volume change at the shock of trading volume change

|          |     | Shock at traders' daily net trading volume |              |              |                |             |              |
|----------|-----|--|--------------|--------------|----------------|-------------|--------------|
|          |     | Positive Shock                             |              |              | Negative Shock |             |              |
|          |     | $CIS_{fxd}$                                | $BANK_{fxd}$ | $FOR_{bd}$   | $FOR_{su}$     | $FOR_{fxd}$ | $BANK_{fxd}$ |
| Positive | 1st | $CIS_{fxd}$                                | $BANK_{fxd}$ | $FOR_{bd}$   | $CIS_{su}$     | $FOR_{su}$  | $CIS_{fxd}$  |
|          | 2nd | $IND_{su}$                                 | $FOR_{su}$   | $FOR_{sd}$   | $IND_{su}$     | $FOR_{fxd}$ | $FI_{fxd}$   |
|          | 3rd | $CIS_{sd}$                                 | $FOR_{bd}$   | $BANK_{fxd}$ | $CIS_{sd}$     | $FI_{bd}$   | $BANK_{bd}$  |
| Negative | 1st | $BANK_{fxd}$                               | $CIS_{fxd}$  | $BANK_{bd}$  | $FOR_{su}$     | $FI_{fxd}$  | $BANK_{fxd}$ |
|          | 2nd | $FOR_{su}$                                 | $FI_{fxd}$   | $FI_{bd}$    | $BANK_{fxd}$   | $IND_{su}$  | $FOR_{su}$   |
|          | 3rd | $IND_{sd}$                                 | $BANK_{bd}$  | $FOR_{su}$   | $IND_{sd}$     | $CIS_{su}$  | $FI_{bd}$    |

[Note]

1. Top 3 positive(negative) responses of traders' daily net trading at shock of trader's daily net trading.
2. The most responsive traders are 6 traders at table 7.  
- positive (negative) shock is given to positively (negatively) responsive trader.
3. Trader  
IND = Individual trader, BANK = Bank, FI = Financial investment, CIS = Collective Investment Scheme,  
OTH = others, INS = Insurance companies, GOV = Government, FOR = Foreign investment
4. Market  
 $su$  = stock,  $sd$  = Stock derivative,  $bu$  = Bond,  $bd$  = Bond derivative,  $fxd$  = FX derivative

## 6.7 Discussion

Combining above results within one picture like from figure 4 market volatility spill over structure can be identified. More detailed results are present from at figure 5 to 10. First of all, the increase of market volatility which is originated from 5 different financial indexes converges to 6 traders' connectedness measures in 1st phase. The shock which converged to 6 influential traders diverges to the daily net trading volumes in different markets in 2nd phase. Then, the shock from sensitive traders in various markets consequently stays at the trader which the shock is given to in 3rd phase.

Above results can be summarised as given below, and suggest the functions of financial traders' network measure and trading activity as a market volatility spill over channel. In particular certain types of traders whose connectedness measures have high sensitivity to financial market volatility, are shown to function as a channel of market volatility spill over under extremely stressed conditions. The volatility which are contagious to some traders, then, can be spread out to different financial markets. Finally there are specific traders who are responsive to other traders' influence and keep the shock in themselves.

Figure 4: Result of analysis on 3 phased market volatility spill over channels

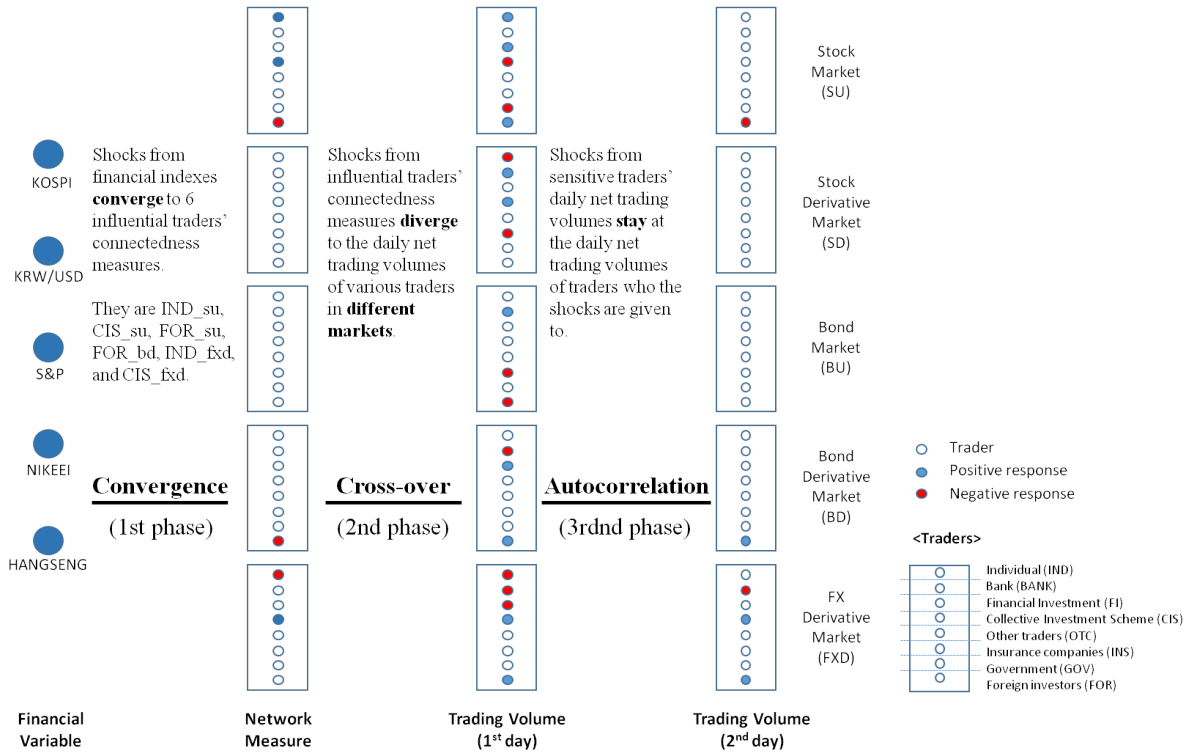

Several important implications to financial policy makers or financial regulators can be also suggested. Given the information of traders' connectedness measures and their trading activity, the financial market stabilization policy can be legislated with the form of more trader-tailored. If the traders can be effectively restricted or incentivized to trade or not, financial market volatility can be more easily stabilized. For instance, Korean government gave the counter incentive to foreign investors to invest in Korean bond market when excessive fund flowed into Korea, while it waived the interest income tax for foreign investors to invest in bond market when the fund flowed out. In line with those policies in the financial market, this research result gives some room to develop more with the empirical evidences.

## 7 Conclusion

In this paper I estimate traders' network structures with both monthly and daily analysis frameworks. For avoiding too restricted econometric assumptions and reflecting actual trading decision making process, expectation forecast which is estimated with one of the machine learning technique, LSTM (Long short term memory), is applied. Network structures are analysed with the connectedness measures. Then, the relations of financial (macro economic) variables, traders' connectedness measures and traders' daily net trading volumes are also investigated with nonlinear impulse response analysis. In particular, traders' connectedness measures and traders' daily net trading volumes are examined whether they play a role as market volatility spill over channels under daily analysis framework.

A few traders such as foreign investors and individual investors are shown to have a strong influence to other traders in particular. This phenomenon is found under both monthly and daily frameworks and the influential traders under each framework are almost same. Those results are consistent with previous literature.

Traders' specific trading patterns at the shock of financial market are identified with monthly analysis framework. Some traders including bank in FX derivative market are found to be more influential at the shock of foreign exchange market and international financial markets. By contrast, other traders like foreign investors in stock derivative market lose their influence but instead trade more independently at the same shock. It is reidentified in this paper that the over-concern about foreign investors' exit from local financial market lacks reasonable evidences.

Finally, traders' connectedness measures are shown to function as market volatility spill over channels based on the result of 3-phased impulse response analysis framework. Regardless of the kind of financial markets, three specific traders' connectedness measures are found to have the most sensitive responses at the shock of financial market. At a shock of one of three traders' connectedness measures, the sensitive traders' trading vol-

ume disperse to different markets. Then, strong autocorrelation is found at the shock of the most sensitive traders' trading volumes.

This paper has a few contributions to previous research and policy makers including financial regulators. First of all, a methodology reflecting actual trading decision making process is used to estimate a network structure in capital markets. Utilising the network structures I enlarge the understanding of relations among traders and further investigate market volatility spill over channels in capital markets. The inter-relations among financial indexes, network measures and net trading volumes of traders can provide the implication for policy makers and financial regulators to enact a new regulation.

There are still a few further research topics. Enhancement of forecasting precision with newly developed machine learning techniques can be possible, for machine learning is one of the most actively studied areas recently. Research on market volatility spill over structure more in depth can be implemented. Reverse impulse relationship between net trading volume, network measure, and financial indexes can be also one of the examples.

Figure 5: Market volatility spill over structure from IND in stock market

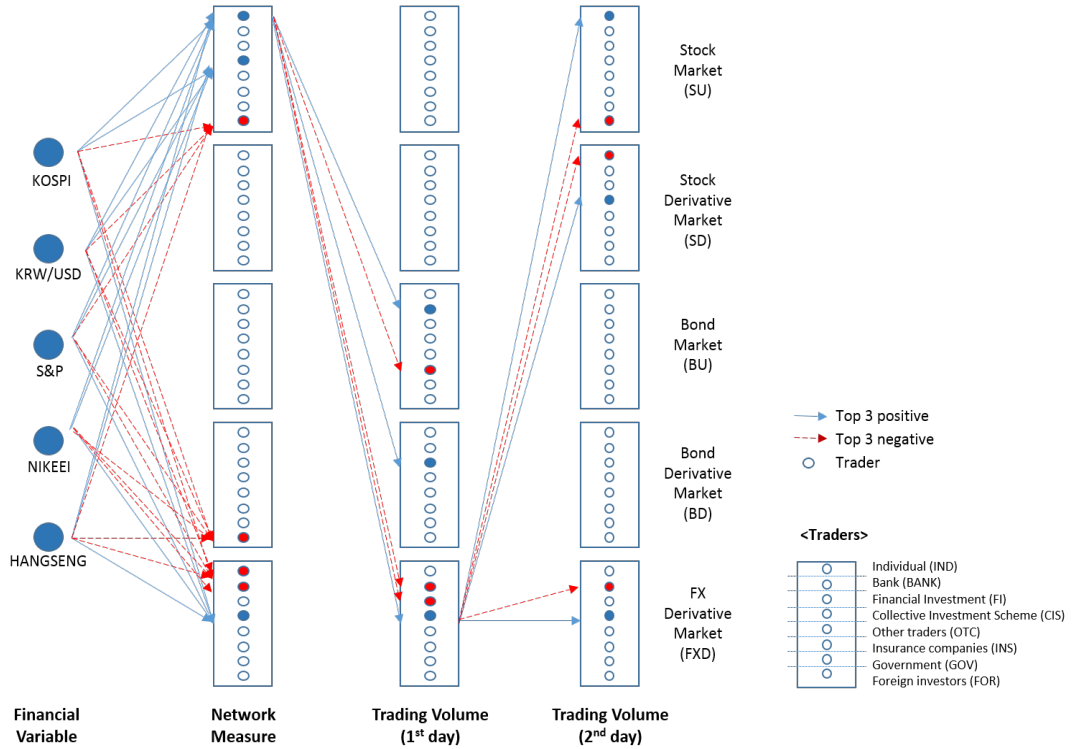

[Notes]

3-phased market volatility spill over channel is present. Since 6 traders are shown the most responsive at the shock of financial variables regardless of the kind of financial variables, the spill over channel which is originated from individual traders in stock market at 2nd phase, is shown.

**(1st phase )**

Impulse : A positive shock on KOSPI, KRW/USD, S&P, NIKKEI, HANGSENG

Response :

Top 3 positive to IND\_su, CIS\_su and CIS\_fxd

Top 3 negative to FOR\_su, FOR\_bd, IND\_fxd

**(2nd phase )**

Impulse : A positive shock on the daily connectedness measure of IND\_su

Response :

Top 3 positive to BANK\_bu, FI\_bd, CIS\_fxd

Top 3 negative to INS\_bu, BANK\_fxd, FI\_fxd

**(3rd phase )**

Impulse : A positive shock on the daily net trading volume of CIS\_fxd

Response :

Top 3 positive to IND\_su, CIS\_sd, CIS\_fxd

Top 3 negative to FOR\_su, IND\_sd, BANK\_fxd

Figure 6: Market volatility spill over structure from CIS in FX derivative market

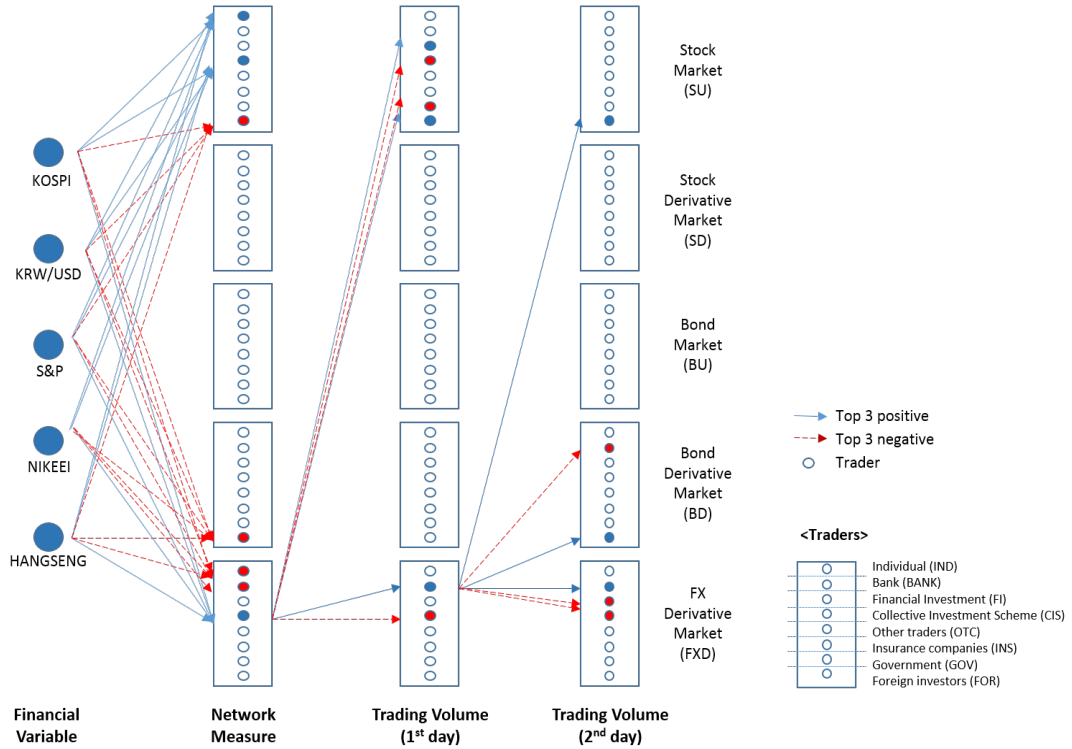

[Notes]

3-phased market volatility spill over channel is present. Since 6 traders are shown the most responsive at the shock of financial variables regardless of the kind of financial variables, the spill over channel which is originated from collective investment scheme in FX derivative market at 2nd phase, is shown.

**(1st phase )**

Impulse : A positive shock on KOSPI, KRW/USD, S&P, NIKKEI, HANGSENG

Response :

Top 3 positive to IND\_su, CIS\_su and CIS\_fxd

Top 3 negative to FOR\_su, FOR\_bd, IND\_fxd

**(2nd phase )**

Impulse : A positive shock on the daily connectedness measure of CIS\_fxd

Response :

Top 3 positive to FI\_su, FOR\_su, BANK\_fxd

Top 3 negative to CIS\_su, GOV\_su, CIS\_fxd

**(3rd phase )**

Impulse : A positive shock on the daily net trading volume of BANK\_fxd

Response :

Top 3 positive to IND\_su, FOR\_bd, BANK\_fxd

Top 3 negative to BANK\_bd, FI\_fxd, CIS\_fxd

Figure 7: System risk spill over structure from CIS in stock market

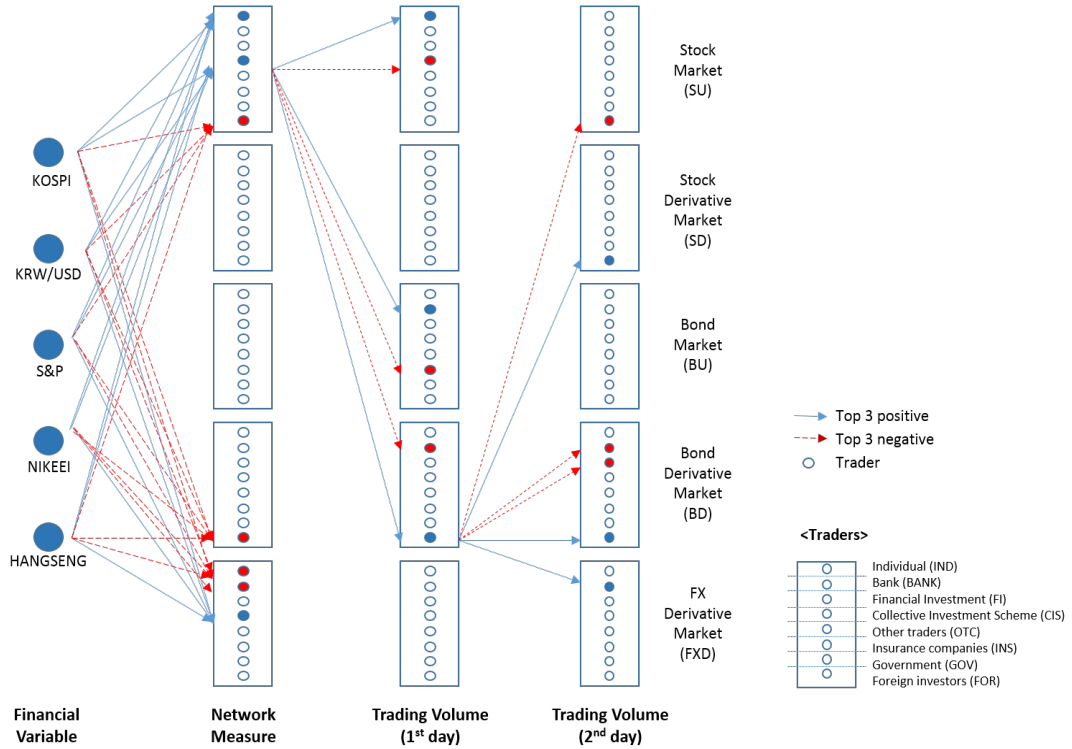

[Notes]

3-phased risk spill over channel is present. Since 6 traders are shown the most responsive at the shock of financial variables regardless of the kind of financial variables, the spill over channel which is originated from collective investment scheme in stock market at 2nd phase, is shown.

**(1st phase )**

Impulse : A positive shock on KOSPI, KRW/USD, S&P, NIKKEI, HANGSENG

Response :

Top 3 positive to IND\_su, CIS\_su and CIS\_fxd

Top 3 negative to FOR\_su, FOR\_bd, IND\_fxd

**(2nd phase )**

Impulse : A positive shock on the daily connectedness measure of CIS\_su

Response :

Top 3 positive to IND\_su, BANK\_bu, FOR\_bd

Top 3 negative to CIS\_su, INS\_bu, BANK\_bd

**(3rd phase )**

Impulse : A positive shock on the daily net trading volume of FOR\_sd

Response :

Top 3 positive to FOR\_sd, FOR\_bd, BANK\_fxd

Top 3 negative to IND\_su, BANK\_bd, FI\_bd



Figure 8: Market volatility spill over structure from FOR in bond derivative market

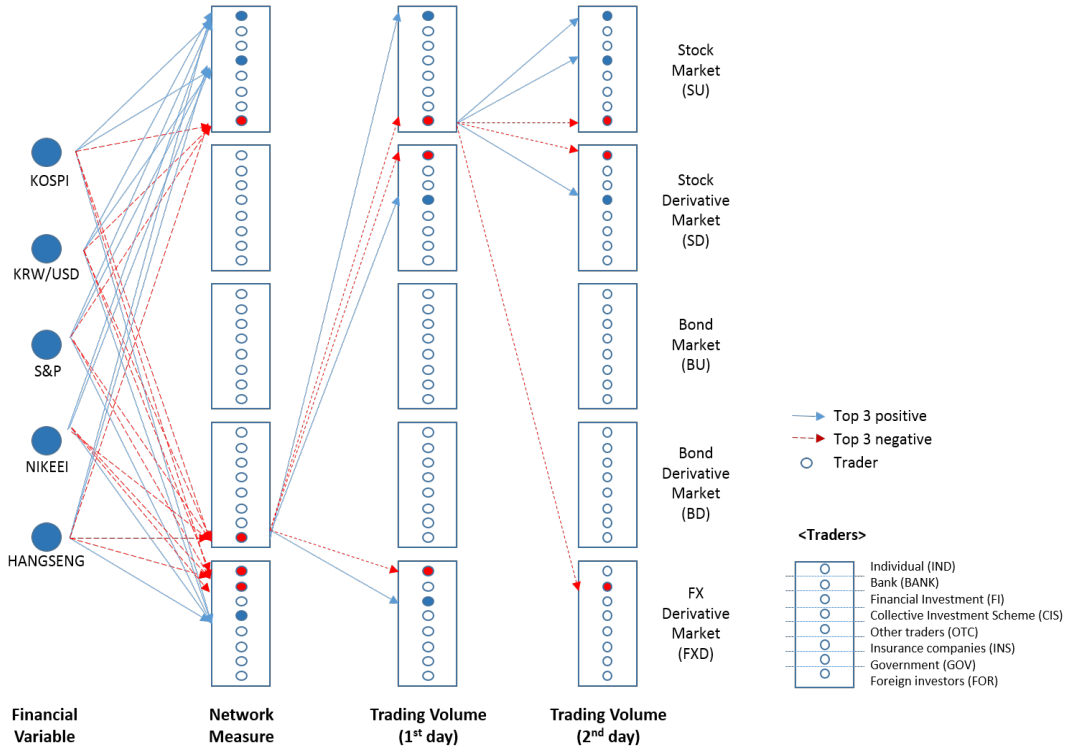

[Notes]

3-phased market volatility spill over channel is present. Since 6 traders are shown the most responsive at the shock of financial variables regardless of the kind of financial variables, the spill over channel which is originated from foreign investors in bond derivative market at 2nd phase, is shown.

**(1st phase )**

Impulse : A positive shock on KOSPI, KRW/USD, S&P, NIKKEI, HANGSENG

Response :

Top 3 positive to IND\_su, CIS\_su and CIS\_fxd

Top 3 negative to FOR\_su, FOR\_bd, IND\_fxd

**(2st phase )**

Impulse : A negative shock on the daily connectedness measure of FOR\_bd

Response :

Top 3 positive to IND\_su, CIS\_sd, FI\_fxd

Top 3 negative to FOR\_su, IND\_sd, IND\_fxd

**(3rd phase )**

Impulse : A negative shock on the daily net trading volume of FOR\_su

Response :

Top 3 positive to IND\_su, CIS\_su, CIS\_sd

Top 3 negative to FOR\_su, IND\_sd, BANK\_fxd

Figure 9: Market volatility spill over structure from IND in FX derivative market

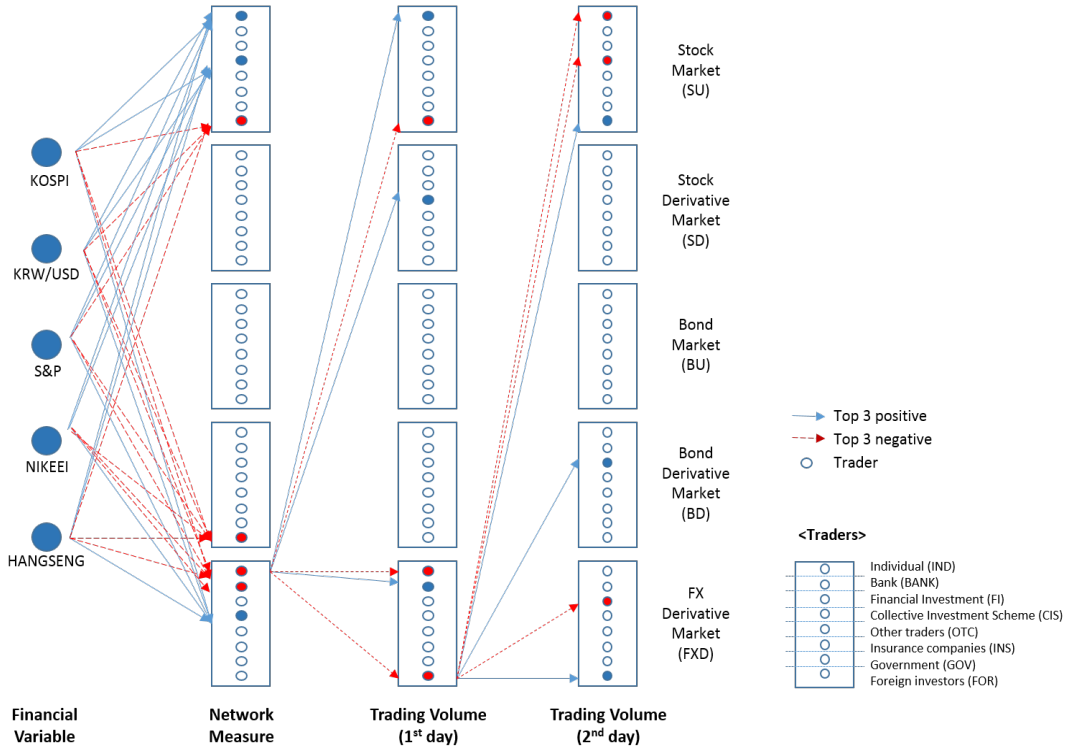

[Notes]

3-phased market volatility spill over channel is present. Since 6 traders are shown the most responsive at the shock of financial variables regardless of the kind of financial variables, the spill over channel which is originated from individual traders in FX derivative market at 2nd phase, is shown.

**(1st phase )**

Impulse : A positive shock on KOSPI, KRW/USD, S&P, NIKKEI, HANGSENG

Response :

Top 3 positive to IND\_su, CIS\_su and CIS\_fxd

Top 3 negative to FOR\_su, FOR\_bd, IND\_fxd

**(2nd phase )**

Impulse : A negative shock on the daily connectedness measure of IND\_fxd

Response :

Top 3 positive to IND\_su, CIS\_sd, BANK\_fxd

Top 3 negative to FOR\_su, IND\_fxd, FOR\_fxd

**(3rd phase )**

Impulse : A negative shock on the daily net trading volume of FOR\_fxd

Response :

Top 3 positive to FOR\_su, FI\_bd, FOR\_fxd

Top 3 negative to IND\_su, CIS\_su, FI\_fxd

Figure 10: Market volatility spill over structure from FOR in stock market

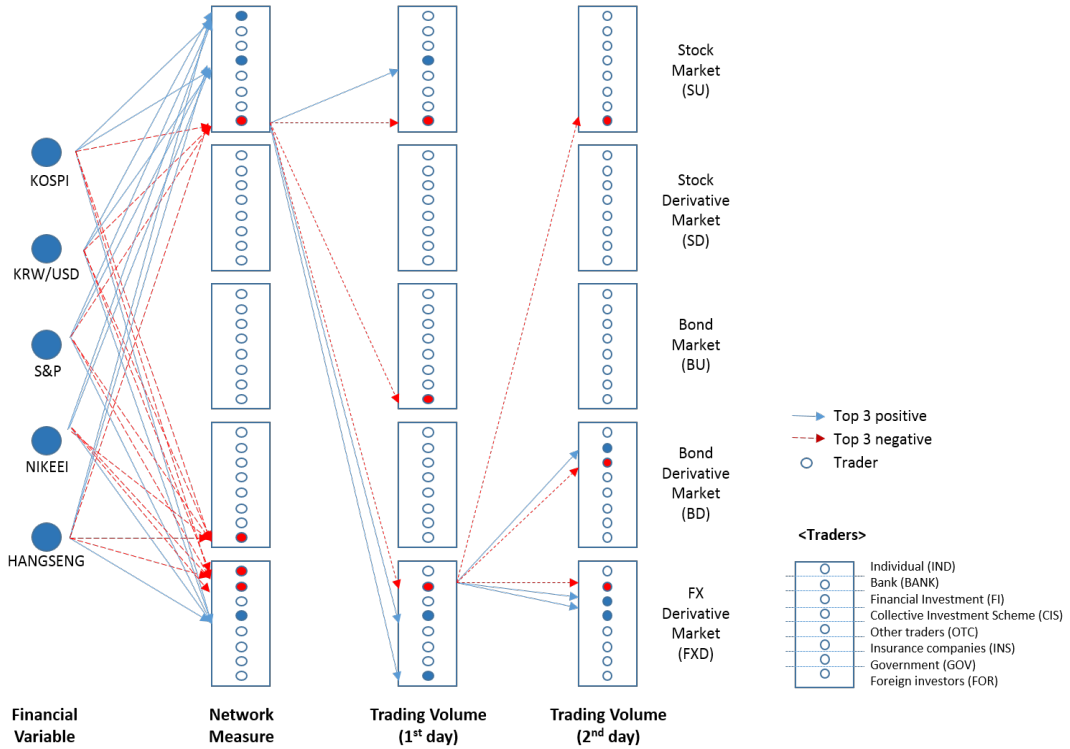

[Notes]

3-phased market volatility spill over channel is present. Since 6 traders are shown the most responsive at the shock of financial variables regardless of the kind of financial variables, the spill over channel which is originated from foreign investors in stock market at 2nd phase, is shown.

**(1st phase )**

Impulse : A positive shock on KOSPI, KRW/USD, S&P, NIKKEI, HANGSENG

Response :

Top 3 positive to IND\_su, CIS\_su and CIS\_fxd

Top 3 negative to FOR\_su, FOR\_bd, IND\_fxd

**(2nd phase )**

Impulse : A negative shock on the daily connectedness measure of FOR\_su

Response :

Top 3 positive to CIS\_su, CIS\_fxd, FOR\_fxd

Top 3 negative to FOR\_su, FOR\_bu, BANK\_fxd

**(3rd phase )**

Impulse : A negative shock on the daily net trading volume of BANK\_fxd

Response :

Top 3 positive to BANK\_bd, FI\_fxd, CIS\_fxd

Top 3 negative to FOR\_su, FI\_bd, BANK\_fxd

# (Appendix A) Forecasting of traders' trading volume on next day

## *A.1. Objective*

I forecast traders' expectation of the other traders' daily net trading volume on next day in order to overcome the restrictive assumption of traditional econometric methods and reflect the actual trading decision process. In traditional econometric models such as VAR (Vector autoregressive model), there is unexplicit assumption, which is that the past determines the future. This assumption, however, is not valid in dynamic financial market environment.

In addition, traders might have an expectation on an influential traders' trading on next day, if there is an influential trader in financial markets. The relation of traders' expectation on a trader's trading on next day and other traders' daily net trading volume can be a clue to investigate traders' network (inter-relations). In a real market, it is hardly to find those data. Thus as a proxy, I forecast the expected value of a trader's daily net trading volume on next day. Because the rational traders' with the public information can be forecasted.

For selecting the most appropriate method to forecast, three different methodologies, which are traditional econometric model (ARMA/ARIMA), Artificial Neural Network (ANN) and Recurrent Neural Network (RNN), are applied to forecast. Three different results are compared with the measures popularly used in previous literature. After the comparison, the method which has best performance is used to forecast for further analysis.

## *A.2. Methodology*

In this part detailed explanations of three methods to forecast are described. Then, forecasting framework is provided.

### ***A.2.1 Econometric method***

For a traditional econometric method, ARMA/ARIMA model by Box and Jenkins is used. Much research tried to forecast financial time series like stock price or currency rate with this method. In order to use this method, the data should be stationary, which can be checked with ADF test. By the results of ADF test, 5 foreign investors' daily net trading volumes are all stationary. Although by Box-Jenkins traditional method a correlogram is used to identify the model, it is sometimes hard to determine with autocorrelation and partial correlation. Therefore, I repeatedly estimate models for foreign investors' daily net trading volumes in 5 different markets which are stock, stock derivative, bond, bond derivative and FX derivative market. Then I compare the results with Akaike Information Criterion(AIC) and select the most appropriate model. After selection model and estimation parameter, Q-test is implemented for checking the residuals are white noises. In addition, in order to see daily change of foreign investors' net trading volume, 1st differential data is also used for analysis. In this case ARIMA model is used, while with level data ARMA model is used.

### ***A.2.2 Artificial Neural Network (ANN)***

ANN is the computing system which operates similar with how biological neural networks do. The smallest unit in ANN is a neuron. Neurons are organized as a set in layer. A simple form of neural network structure consists of input, hidden and output layers as shown in the figure 11. For the objectives of analysis more hidden layers can be added in the network. Neurons in each layer are connected to the neurons in other layers. What matters here is that the connection only can be possible between neighboring layers (e.g. between input and hidden and between hidden and output), and that the information flows unidirectionally from input to hidden and from hidden to output, which is called forward propagation. The connection between neurons can be represented mathematically with weight ( $\omega$ ), bias ( $b$ ) and activation function ( $\phi$ ).

At first I denote  $x^i$  and  $y^i$  relatively  $i$ th sample of whole data. In real forecasting,  $x^i$

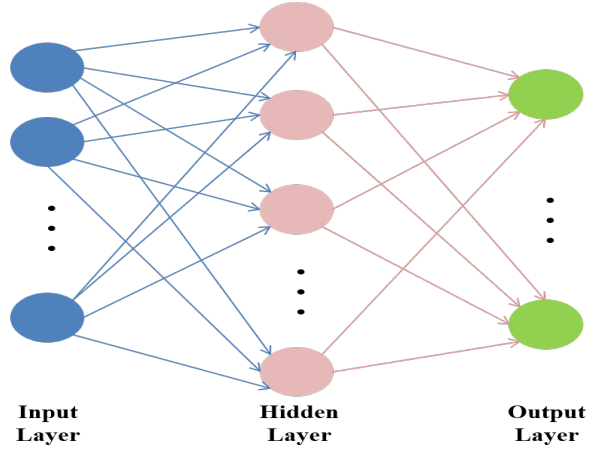

Figure 11: The structure of an artificial neural network

is the vector of traders' net trading volumes and  $y^i$  is a certain trader's trading volume next day. Here  $x$  ( $x \in \mathbb{R}^n$ ) is the components of input layers and  $y$  is the value of output layer.  $y$  is binary or trinary variable in classification model, but in regression model, it can be any value between  $-1$  and  $1$ . In order to get the value between  $-1$  and  $1$  the data is generally normalized, but in this present paper all values of net trading volumes are within  $-1$  and  $1$  already. Let  $z^m$  be the variables in hidden layer.  $m$  can be determined by trial and error in practice. The relationship between  $x$ ,  $y$  and  $z$  can be expressed like below equations.

$$z = \phi_1(x\omega_1 + b_1) \quad (16)$$

$$\hat{y} = \phi_2(z\omega_2 + b_2) \quad (17)$$

$\omega_1$  and  $\omega_2$  are the weights and  $b_1$  and  $b_2$  are random numbers.  $\omega_1$  is  $n$  by  $m$  matrix and  $\omega_2$  is  $m$  by  $1$  matrix.  $\phi$  is the activation function, which is able to tackle nonlinearity of data. The most popular activation function is sigmoid (logistic) function or hyperbolic tangent activation function. In present paper, I use sigmoid as  $\phi_1$  and hyperbolic tangent activation function(tanh) as  $\phi_2$ , for the value of daily net trading volume is between  $-1$  and  $1$ .

$$\phi_1(x) = \frac{1}{1 + e^{-x}} = \text{sigmoid}(x) \quad (18)$$

$$\phi_2(x) = \frac{e^x - e^{-x}}{e^x + e^{-x}} = \text{tanh}(x) \quad (19)$$

The core process of artificial neural network is to find the most appropriate weight in above equation. This process is called to train the network. For training, loss function is essentially needed. One of the most popular loss function is mean squared errors as given below.  $K$  is output layer's dimension. Here output layer is 1 and total cost function is given below. The process to seek optimal weights is iterative forward propagations to minimize loss function, which is called optimization. In this process the weights play important roles to forecast an output accurately since it is continually adjusted to seek for local minima place of loss function as seen in the below equation.

$$J_i(W, x^i, y^i) = \frac{1}{2} \sum_{k=1}^K (\hat{y}_k^i - y_k^i)^2 \quad (20)$$

$$J(W) = \frac{1}{S} \sum_{i=1}^S J_i(W, x^i, y^i) \quad (21)$$

where  $W$  is the vectors of weights ( $\omega_1$  and  $\omega_2$ ) and  $S$  is the number of total samples.

Many optimization methods have been introduced. The simplest one is gradient descent, which is the way to find local minima with below equation. The weight is continually updated subtracting the multiplication of learning rate  $\eta$  which is also determined by trial and error and loss functions' gradient.  $\omega_2$  is also calculated with same fashion. For standard gradient descent which is called batch gradient descent, entire training set is used in this optimization process.

$$\omega_1^{(l)}(n+1) = \omega_1^{(l)}(n) - \eta \frac{\partial J(n)}{\partial \omega_1^{(l)}(n)} \quad (22)$$

In order to overcome this inefficient computation, Stochastic Gradient Descent (SGD)

was developed. In case of SGD, the weights are updated after each sample data like below equation. In this paper, Adam(A method for stochastic optimization) which is one of the variants of SGD is used. Instead of using constant learning rate in case of SGD, Adam computes adaptive learning rate with first and second moment estimates of the gradients. Adam is now one of the most commonly used optimization method(Sebastian Ruder, 2016).

$$\omega_1^{(l)}(n+1) = \omega_1^{(l)}(n) - \eta \frac{\partial J_i(n)}{\partial \omega_1^{(l)}(n)} \quad (23)$$

The last step of training is the calculation of gradient. The gradients are calculated by chain rule, which was introduced by Rumelhart et al.(1986). This process to update weights is called backpropagation. Unlike forward propagation, the adjustment process for weight is implemented backward. Using the partial derivative of loss function with respect to the weights, new weights of hidden layer for computing output layer can be computed. New weights of input layer for hidden layer are similarly calculated. Through the iteration over forward propataion and backpropagation to minimize loss function, the network can be trained.

For training a network, the initial values of weights are needed. Although for many cases random numbers are used as initial weights, it would sometimes make a problem such as being stuck in local minima, which leads to failing to find minimum value of loss function and finally poor learning. Much research have tried to solve this problem. Recently normalized initialization which was suggested by Glorot and Bengio (2010) is one of the most commonly used. In this paper, normalized initialization is used.

The biggest drawback of machine learning is over fitting, which is that the result of train set is accurate, but the result of test set is not accurate enough. There are multiple ways to tackle overfitting. One instance is regularization with a regularization term in loss function. This regularization term penalizes big weights. Loss function with regularization term is given below.  $\lambda$  is the parameter, n and m is relatively the number of neurons in input and hidden layer.



$$J_i(W, x^i, y^i)_{new} = J_i(W, x^i, y^i)_{old} + \frac{\lambda}{2} \sum_{j=1}^n \sum_{k=1}^m (\omega)^2 \quad (24)$$

Dropout is also a popular method to avoid over fitting. This methods is to drop some neurons randomly as training unfolds, which helps not to be overly trained in train set.

### A.2.3 Recurrent Neural Network (RNN)

Recurrent Neural Network (RNN) is a kind of neural network techniques with sequential information. Unlike normal multi-layer neural network, RNN uses the information of past input data. Long Short Term Memory (LSTM) is a variant of RNN which has been introduced by Hochreiter and Schmidhuber (1997) and very commonly used since. As seen in the figure 12, LSTM has a particular structure like chain and in an each module there are special tools which are called relatively forget gate, input gate and output gate.

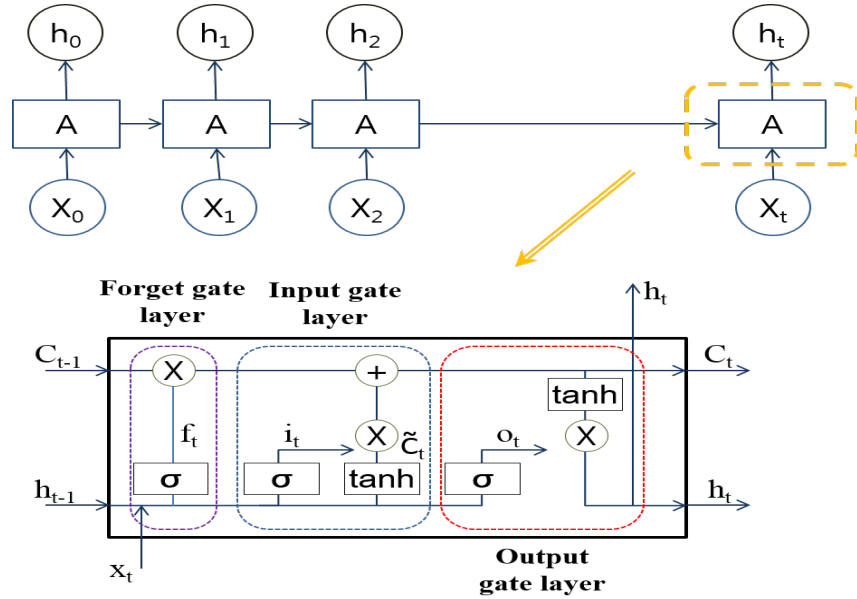

Figure 12: The structure of an LSTM

In LSTM cell state  $C_t$  and horizontal line  $h_t$  have critical roles. As forget gate manages the information from input vector  $x$ , the target value will be drawn. First of all, forget gate layer decides which information to forget, as seen in the equation.  $x_t$  is the input vector at time  $t$ ,  $h_{t-1}$  output at time  $t-1$ ,  $W_f$  is the weight vector,  $b_f$  is random vector,

and  $\sigma$  is activation function, which here it is sigmoid(logistic) function. Sigmoid function gives output between 1 and 0 and the information of input vector  $x$  can be delivered to the cell state as optimally needed amount.

$$f_t = \sigma(W_f[h_{t-1}, x_t] + b_f) \quad (25)$$

Nextly, input gate layer  $i_t$  chooses which information important and new candidate values  $\tilde{C}_t$  updates cell state  $C_t$  as shown in equation.

$$i_t = \sigma(W_i[h_{t-1}, x_t] + b_i) \quad (26)$$

$$\tilde{C}_t = \tanh(W_C[h_{t-1}, x_t] + b_C) \quad (27)$$

$$C_t = f_t \times C_{t-1} + i_t \times \tilde{C}_t \quad (28)$$

Final step is the output which is calculated with the multiplication of output layer  $o_t$  and hyperbolic tangent of new cell state  $C_t$ .

$$o_t = \sigma(W_o[h_{t-1}, x_t] + b_o) \quad (29)$$

$$h_t = o_t \times \tanh(C_t) \quad (30)$$

Although training RNN seems very similar with ANN, there are a few points needed to consider. First of all, RNN share the weight parameters throughout all steps while multi-layer ANN estimate different values of weight parameters at each layers. Due to this attribute, in backpropagation of RNN the gradient at previous steps should be calculated, which is called Backpropagation Through Time (BPTT).

The training procedures including mean squared errors loss function, Adam optimization, nomalized initializer are all same with ANN.

#### ***A.2.4 Forecasting framework***

For estimating forecasting model, the data from 2006 to 2013 is used. For machine learning this period is commonly called as train period. The data during 2014 and 2015 is used to test the forecasting model.

For independent variables, which are input variables in machine learning methods, 40 traders' net trading volumes on previous day are used. Each types of investors' daily net trading volume in each market on next day is used as dependent variable, which is output variable in machine learning method.

First of all, ARMA model is estimated. For enhancing prediction power, the variables with statistically significant coefficients at the results of simple regression with 40 net trading volumes as independent variables, are included in ARMA model estimation. Based on AIC (Akaike information criteria), the most appropriate model is selected for each foreign investors' net trading volume. Although all variables are stationary, 1st differential data are analyzed in order to see the change of traders' daily net trading volume. For 1st differential data, model selection procedure is same with level data and the selected model is equivalent with ARIMA model of level data.

For comparison objective, the input data for ANN and LSTM are chosen as same as ARMA and ARIMA model.

### ***A.3. Forecast results***

#### ***A.3.1 Performance measure***

For the comparison of forecasting power of each model, the values of most commonly used measures are calculated. These are RMSE, MAE, MAPE and NMSE.

- Root mean square error(RMSE)

$$RMSE = \sqrt{\frac{1}{N} \sum_{n=1}^N (x_{t+1}^n - \hat{x}_{t+1}^n)^2} \quad (31)$$

- Mean absolute error (MAE)

$$MAE = \frac{1}{N} \sum_{n=1}^N |x_{t+1}^n - \hat{x}_{t+1}^n| \quad (32)$$

- Normalized Mean Squared Error (NMSE)

$$NMSE = \frac{1}{N} \frac{\sum_{n=1}^N (x_{t+1}^n - \hat{x}_{t+1}^n)^2}{var(x_{t+1}^n)} \quad (33)$$

### ***A.3.2 Forecasting result***

Foreign investors' daily net trading volumes are forecasted with ARMA/ARIMA model, ANN and LSTM model. The forms of forecasted data are both level and 1st differential net trading volumes. Level data can be seen as a snapshot of foreign investors' trading on next day, whereas 1st differential value can be meaningful since it shows dynamic change of trading behaviour. The forecasting performances are assessed with 3 measures (RMSE, MAE, and NMSE). In addition, the results of train and test set are also relatively given for comparison purpose. Train set is the data for estimating model and the test set is the data which is not used to estimate the model.

Forecasting Results data are presented on table 9. Overall forecasting performances of LSTM are more precise than other methods. This is valid in different markets, different data sources which are train and test set, and different data type which are level and 1st difference.

However, it is hard to recognize the performance difference between the models in some cases such as level data in bond market and 1st difference data in stock derivative market.

Table 9: Prediction performance

|                                |       | Level |      |      | 1st Diff. |      |      |
|--------------------------------|-------|-------|------|------|-----------|------|------|
|                                |       | RMSE  | MAE  | NMSE | RMSE      | MAE  | NMSE |
| <i>Stock market</i>            |       |       |      |      |           |      |      |
| Train                          | ARIMA | 0.75  | 0.58 | 1.47 | 0.52      | 0.43 | 0.73 |
|                                | ANN   | 0.55  | 0.43 | 0.79 | 0.52      | 0.43 | 0.73 |
|                                | LSTM  | 0.51  | 0.41 | 0.68 | 0.50      | 0.42 | 0.68 |
| Test                           | ARIMA | 0.77  | 0.59 | 1.00 | 0.54      | 0.44 | 1.00 |
|                                | ANN   | 0.55  | 0.43 | 1.00 | 0.53      | 0.45 | 1.00 |
|                                | LSTM  | 0.51  | 0.42 | 1.00 | 0.51      | 0.43 | 1.00 |
| <i>Stock derivative market</i> |       |       |      |      |           |      |      |
| Train                          | ARIMA | 0.96  | 0.80 | 0.80 | 0.73      | 0.67 | 0.99 |
|                                | ANN   | 0.90  | 0.76 | 0.70 | 0.73      | 0.67 | 0.99 |
|                                | LSTM  | 0.87  | 0.74 | 0.67 | 0.73      | 0.67 | 0.98 |
| Test                           | ARIMA | 0.91  | 0.75 | 1.00 | 0.74      | 0.67 | 1.00 |
|                                | ANN   | 0.87  | 0.72 | 1.00 | 0.74      | 0.68 | 1.00 |
|                                | LSTM  | 0.84  | 0.71 | 1.00 | 0.74      | 0.68 | 1.00 |
| <i>Bond market</i>             |       |       |      |      |           |      |      |
| Train                          | ARIMA | 0.18  | 0.13 | 0.78 | 0.44      | 0.37 | 6.20 |
|                                | ANN   | 0.18  | 0.13 | 0.77 | 0.17      | 0.11 | 0.90 |
|                                | LSTM  | 0.18  | 0.13 | 0.75 | 0.16      | 0.11 | 0.84 |
| Test                           | ARIMA | 0.17  | 0.12 | 1.00 | 0.45      | 0.39 | 1.01 |
|                                | ANN   | 0.17  | 0.12 | 1.00 | 0.14      | 0.10 | 1.00 |
|                                | LSTM  | 0.17  | 0.12 | 1.00 | 0.14      | 0.10 | 1.00 |
| <i>Bond derivative market</i>  |       |       |      |      |           |      |      |
| Train                          | ARIMA | 0.77  | 0.61 | 0.98 | 0.66      | 0.54 | 1.06 |
|                                | ANN   | 0.69  | 0.55 | 0.77 | 0.62      | 0.54 | 0.93 |
|                                | LSTM  | 0.70  | 0.55 | 0.80 | 0.61      | 0.52 | 0.89 |
| Test                           | ARIMA | 0.87  | 0.69 | 1.00 | 0.73      | 0.60 | 1.00 |
|                                | ANN   | 0.78  | 0.63 | 1.00 | 0.68      | 0.59 | 1.00 |
|                                | LSTM  | 0.78  | 0.63 | 1.00 | 0.67      | 0.58 | 1.00 |
| <i>FX derivative market</i>    |       |       |      |      |           |      |      |
| Train                          | ARIMA | 0.64  | 0.52 | 0.68 | 0.53      | 0.44 | 0.99 |
|                                | ANN   | 0.64  | 0.52 | 0.68 | 0.52      | 0.44 | 0.98 |
|                                | LSTM  | 0.58  | 0.48 | 0.57 | 0.52      | 0.44 | 0.98 |
| Test                           | ARIMA | 0.83  | 0.68 | 1.00 | 0.64      | 0.56 | 1.00 |
|                                | ANN   | 0.82  | 0.68 | 1.00 | 0.63      | 0.56 | 1.00 |
|                                | LSTM  | 0.74  | 0.62 | 1.00 | 0.63      | 0.56 | 1.00 |

[Note]

RMSE = Root Mean Square Error, MAE = Mean Absolute Error,  
 NMSE = Normalized Mean Squared Error

Though, the forecasting performance of LSTM is not worse than others in those cases.

Overfitting problem can be raised by the performance difference between train and test sets. If the forecasting performance of train set is overwhelmingly better than one of test set, over fitting problem needs to be doubted. In this case, the model which is overly optimized for train data, cannot forecast appropriately. Based on table 9, significant overfitting doesn't seem problematic although performance differences between train and test set found in bond derivative and FX derivative market. In addition, the consistency for estimating models can be lost if the process to estimate model is changed in order to avoid a little overfitting problem.

#### ***A.4. Discussion***

Forecasting results in 5 different financial markets differ. In most case LSTM shows the best performance, while in some cases no significantly better forecasting power among 3 methods is hardly found. Therefore, forecasting result with LSTM is used for subsequent analyses.

## References

- Akerlof, G. A. & Shiller, R. J. (2010), *Animal spirits: How human psychology drives the economy, and why it matters for global capitalism*, Princeton university press.
- Alpaydin, E. (2014), *Introduction to machine learning*, MIT press.
- Atsalakis, G. S. & Valavanis, K. P. (2009), ‘Surveying stock market forecasting techniques-part ii: Soft computing methods’, *Expert Systems with Applications* **36**(3), 5932–5941.
- Box, G. E. & Jenkins, G. M. (1976), ‘Time series analysis, control, and forecasting’, *San Francisco, CA: Holden Day* **3226**(3228), 10.
- Bullard, J. B. (2006), ‘The learnability criterion and monetary policy’, *REVIEW-FEDERAL RESERVE BANK OF SAINT LOUIS* **88**(3), 203.
- Cao, L.-J. & Tay, F. E. H. (2003), ‘Support vector machine with adaptive parameters in financial time series forecasting’, *IEEE Transactions on neural networks* **14**(6), 1506–1518.
- Chaudhuri, T. D. & Ghosh, I. (2016), ‘Artificial neural network and time series modeling based approach to forecasting the exchange rate in a multivariate framework’, *arXiv preprint arXiv:1607.02093*.
- Chaudhuri, T. D., Ghosh, I. & Singh, P. (2017), ‘Application of machine learning tools in predictive modeling of pairs trade in indian stock market’, *IUP Journal of Applied Finance* **23**(1), 5.
- Chen, H., Xiao, K., Sun, J. & Wu, S. (2017), ‘A double-layer neural network framework for high-frequency forecasting’, *ACM Transactions on Management Information Systems (TMIS)* **7**(4), 11.
- Claveria, O., Monte, E. & Torra, S. (2017), ‘Regional tourism demand forecasting with machine learning models: Gaussian process regression vs. neural network models in a multiple-input multiple-output setting’.

- De Faria, E., Albuquerque, M. P., Gonzalez, J., Cavalcante, J. & Albuquerque, M. P. (2009), ‘Predicting the brazilian stock market through neural networks and adaptive exponential smoothing methods’, *Expert Systems with Applications* **36**(10), 12506–12509.
- Dhingra, V. S., Bulsara, H. P. & Gandhi, S. (2017), ‘Forecasting foreign institutional investment flows towards india using arima modelling’, *Management: Journal of Sustainable Business and Management Solutions in Emerging Economies* **20**(75), 13–26.
- Diaz, J. F. & Chen, J.-H. (2017), ‘Testing for long-memory and chaos in the returns of currency exchange-traded notes (etns)’, *Journal of Applied Finance and Banking* **7**(4), 15.
- Gao, S. & Lei, Y. (2017), ‘A new approach for crude oil price prediction based on stream learning’, *Geoscience Frontiers* **8**(1), 183–187.
- Ghulam, Y. & Doering, J. (2017), ‘Spillover effects among financial institutions within germany and the united kingdom’, *Research in International Business and Finance* .
- Guidolin, M. & Pedio, M. (2017), ‘Identifying and measuring the contagion channels at work in the european financial crises’, *Journal of International Financial Markets, Institutions and Money* **48**, 117–134.
- Heemeijer, P., Hommes, C., Sonnemans, J. & Tuinstra, J. (2009), ‘Price stability and volatility in markets with positive and negative expectations feedback: An experimental investigation’, *Journal of Economic dynamics and control* **33**(5), 1052–1072.
- Herbst, A. F., Kare, D. D. & Caples, S. (1989), ‘Hedging effectiveness and minimum risk hedge ratios in the presence of autocorrelation: foreign currency futures’, *Journal of Futures Markets* **9**(3), 185–197.
- Hernandez, E. (2017), ‘Volatility of main metals forecasted by a hybrid ann-garch model with regressors’, *Expert Systems with Applications* **84**, 290–300.
- Hwang, J. (2018a), ‘Analysis on traders’ financial network and market volatility’.
- Hwang, J. (2018b), ‘Nonlinear analysis on traders’ financial network and market volatility’.



- Jeong, D. & Park, S. (2017), 'The more connected, the better? impact of connectedness on volatility and price discovery in the korean financial sector', *Managerial Finance* (just-accepted), 00–00.
- Kara, G., Tian, M. H. & Yellen, M. (2015), 'Taxonomy of studies on interconnectedness'.
- Keynes, J. (1936), 'The general theory of employment, interest and money'.
- Khwaja, A., Zhang, X., Anpalagan, A. & Venkatesh, B. (2017), 'Boosted neural networks for improved short-term electric load forecasting', *Electric Power Systems Research* **143**, 431–437.
- Koop, G., Pesaran, M. H. & Potter, S. M. (1996), 'Impulse response analysis in nonlinear multivariate models', *Journal of econometrics* **74**(1), 119–147.
- Leung, H., Schiereck, D. & Schroeder, F. (2017), 'Volatility spillovers and determinants of contagion: Exchange rate and equity markets during crises', *Economic Modelling* **61**, 169–180.
- ller, L.-E. (1985), 'Macroeconomic forecasting with a vector arima model: A case study of the finnish economy', *international Journal of Forecasting* **1**(2), 143–150.
- Mahmoudi, S., Mahmoudi, S. & Mahmoudi, A. (2017), 'Prediction of earnings management by use of multilayer perceptron neural networks with two hidden layers in various industries', *Journal of Entrepreneurship, Business and Economics* **5**(1), 216–236.
- Majhi, R., Panda, G. & Sahoo, G. (2009), 'Efficient prediction of exchange rates with low complexity artificial neural network models', *Expert Systems with Applications* **36**(1), 181–189.
- Maknickien, N., Rutkauskas, A. V. & Maknickas, A. (2011), 'Investigation of financial market prediction by recurrent neural network', *Innovative Technologies for Science, Business and Education* **2**(11), 3–8.
- Malik, F., Wang, F. & Naseem, M. A. (2017), 'Econometric estimation of banking stocks', *The Journal of Developing Areas* **51**(4), 207–237.

- Mehran, J. & Shahrokhi, M. (1997), ‘An application of four foreign currency forecasting models to the us dollar and mexican peso’, *Global Finance Journal* **8**(2), 211–220.
- Muth, J. F. (1961), ‘Rational expectations and the theory of price movements’, *Econometrica: Journal of the Econometric Society* pp. 315–335.
- Muzhou, H., Taohua, L., Yunlei, Y., Hao, Z., Hongjuan, L., Xiugui, Y. & Xinge, L. (2017), ‘A new hybrid constructive neural network method for impacting and its application on tungsten price prediction’, *Applied Intelligence* **47**(1), 28–43.
- Nagayasu, J. (2003), *The efficiency of the Japanese equity market*, Emerald Group Publishing Limited, pp. 155–171.
- Newman, M. (2010), *Networks: an introduction*, Oxford university press.
- Parida, A., Bisoi, R., Dash, P. & Mishra, S. (2017), ‘Times series forecasting using chebyshev functions based locally recurrent neuro-fuzzy information system’, *INTERNATIONAL JOURNAL OF COMPUTATIONAL INTELLIGENCE SYSTEMS* **10**(1), 375–393.
- Pei, X. & Zhu, S. (2017), *Measurements of Financial Contagion: A Primary Review from the Perspective of Structural Break*, Springer, pp. 61–84.
- Pradeepkumar, D. & Ravi, V. (2017), ‘Forecasting financial time series volatility using particle swarm optimization trained quantile regression neural network’, *Applied Soft Computing* **58**, 35–52.
- Prat, G. & Uctum, R. (2015), ‘Expectation formation in the foreign exchange market: a time-varying heterogeneity approach using survey data’, *Applied Economics* **47**(34-35), 3673–3695.
- Sargent, T. J. (1993), ‘Bounded rationality in macroeconomics: The arne ryde memorial lectures’, *OUP Catalogue* .

- Sokolov-Mladenovi, S., Milovanevi, M., Mladenovi, I. & Alizamir, M. (2016), ‘Economic growth forecasting by artificial neural network with extreme learning machine based on trade, import and export parameters’, *Computers in Human Behavior* **65**, 43–45.
- Sole Pagliari, M. & Ahmed, S. (2017), ‘The volatility of capital flows in emerging markets: Measures and determinants’.
- Son, Y., Byun, H. & Lee, J. (2016), ‘Nonparametric machine learning models for predicting the credit default swaps: An empirical study’, *Expert Systems with Applications* **58**, 210–220.
- Song, X. & Taamouti, A. (2016), ‘Measuring nonlinear granger causality in mean’, *Journal of Business and Economic Statistics* (just-accepted), 1–37.
- Tedeschi, G., Iori, G. & Gallegati, M. (2012), ‘Herding effects in order driven markets: The rise and fall of gurus’, *Journal of Economic Behavior & Organization* **81**(1), 82–96.
- ter Ellen, S., Verschoor, W. F. & Zwinkels, R. C. (2013), ‘Dynamic expectation formation in the foreign exchange market’, *Journal of International Money and Finance* **37**, 75–97.
- Tsay, R. S. (2000), ‘Time series and forecasting: Brief history and future research’, *Journal of the American Statistical Association* **95**(450), 638–643.
- Tse, R. Y. (1997), ‘An application of the arima model to real-estate prices in hong kong’, *Journal of Property Finance* **8**(2), 152–163.
- Wang, Y.-H. (2009), ‘Nonlinear neural network forecasting model for stock index option price: Hybrid gjrgarch approach’, *Expert Systems with Applications* **36**(1), 564–570.
- Wei, Q. & Zhang, Q. (2016), ‘P2p lending risk contagion analysis based on a complex network model’, *Discrete Dynamics in Nature and Society* **2016**.
- Wu, B. & Duan, T. (2017), ‘The fractal feature and price trend in the gold future market at the shanghai futures exchange (sfe)’, *Physica A: Statistical Mechanics and its Applications* **474**, 99–106.

Zhang, Y. & Wu, L. (2009), 'Stock market prediction of s&p 500 via combination of improved bco approach and bp neural network', *Expert systems with applications* **36**(5), 8849–8854.